

## 1-Line, Bi-directional, Transient Voltage Suppressor

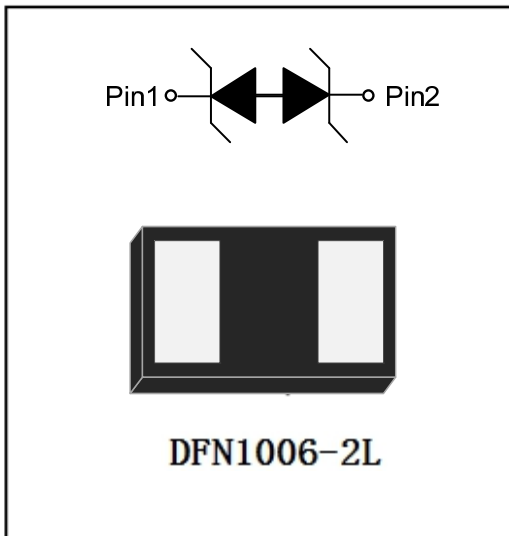

### Features

- Stand-off voltage:  $\pm 4.5\text{V}$  Max
- Transient protection for each line according to IEC61000-4-2(ESD):  $\pm 30\text{kV}$  (contact)  
IEC61000-4-4 (EFT): 40A (5/50ns)  
IEC61000-4-5(surge): 40A (8/20 $\mu\text{s}$ )
- Ultra-low capacitance:  $C_J = 65\text{pF}$  typ
- Low leakage current
- Low clamping voltage:  $V_{CL} = 7.0\text{V}$  typ. @  $I_{PP} = 16\text{A}$  (TLP)
- Solid-state silicon technology

### Mechanical Data

- **Package:** DFN1006-2L
- **Terminals:** Tin plated leads, solderable per J-STD-002 and JESD22-B102
- **Polarity:** No marking on bi-directional types
- **Marking:** 4G

### ■ Definitions of electrical characteristics

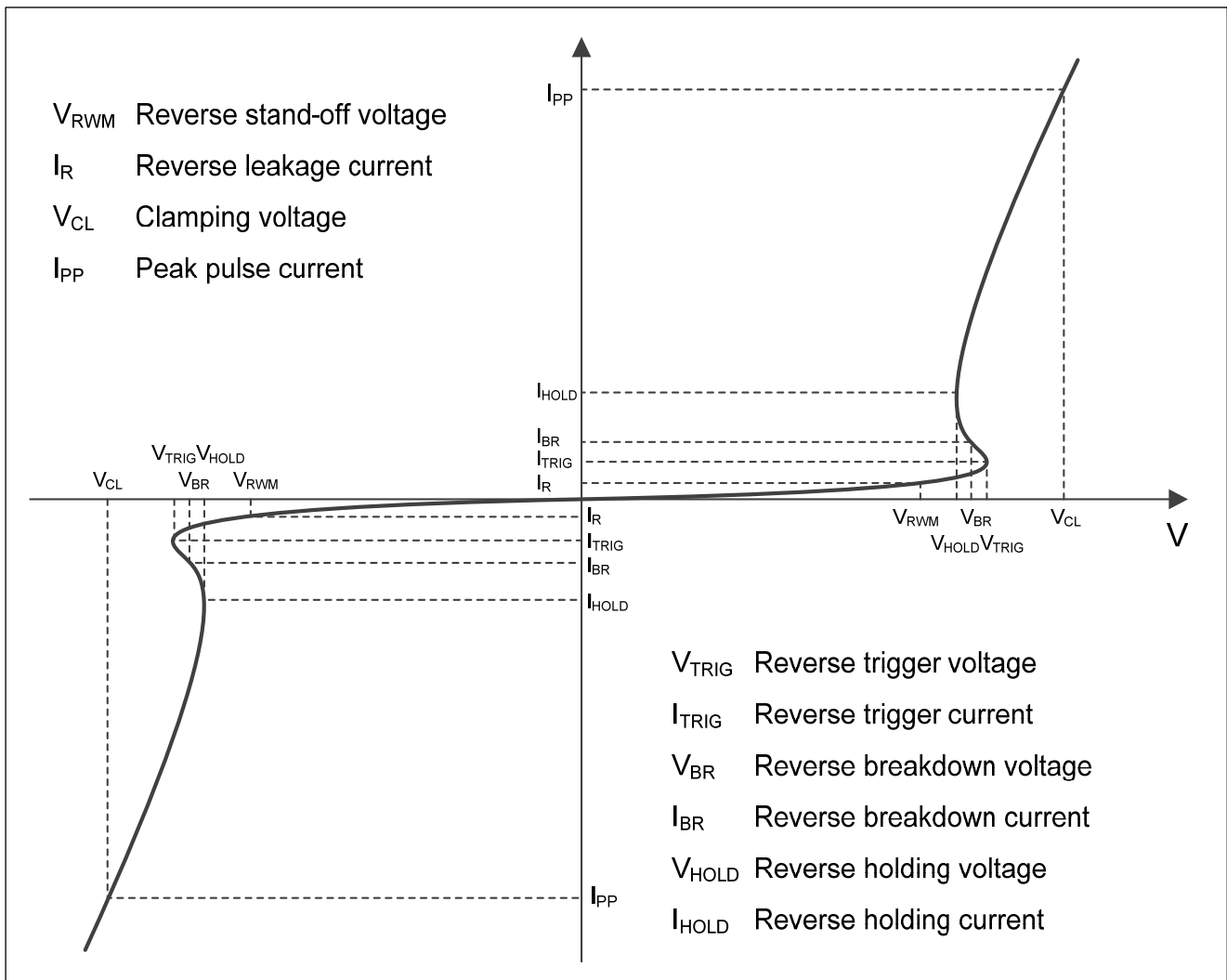



# ESD4V5LBA

## ■Maximum Ratings

PARAMETER	SYMBOL	Rating	UNIT
Peak pulse power ( $t_p = 8/20\mu s$ )	$P_{pk}$	400	W
Peak pulse current ( $t_p = 8/20\mu s$ )	$I_{PP}$	40	A
ESD according to IEC61000-4-2 air discharge	$V_{ESD}$	$\pm 30$	KV
ESD according to IEC61000-4-2 contact discharge		$\pm 30$	KV
Junction temperature	$T_J$	125	$^{\circ}C$
Operating temperature	$T_{OP}$	-40~85	$^{\circ}C$
Storage temperature	$T_{STG}$	-55~150	$^{\circ}C$

## ■Electrical Characteristics ( $T_a=25^{\circ}C$ Unless otherwise specified)

PARAMETER	Symbol	UNIT	Conditions	Min	Typ	Max
Reverse maximum working voltage	$V_{RWM}$	V				$\pm 4.5$
Reverse leakage current	$I_R$	$\mu A$	$V_{RWM} = \pm 4.5V$			1
Reverse breakdown voltage	$V_{BR}$	V	$I_{BR} = 1mA$	4.6		
Clamping voltage <sup>1)</sup>	$V_{CL}$	V	$I_{PP} = 16A, t_p = 100ns$		7	
Dynamic resistance <sup>1)</sup>	$R_{DYN}$	$\Omega$			0.09	
Clamping voltage <sup>2)</sup>	$V_{CL}$	V	$V_{ESD} = 8kV$		9	
Clamping voltage <sup>3)</sup>	$V_{CL}$	V	$I_{PP} = 1A, t_p = 8/20\mu s$		4.9	6
		V	$I_{PP} = 20A, t_p = 8/20\mu s$		6.5	8
		V	$I_{PP} = 40A, t_p = 8/20\mu s$		9	10
Junction capacitance	$C_J$	$\mu F$	$V_R = 0V, f = 1MHz$		65	75

(1). TLP parameter:  $Z_0 = 50\Omega, t_p = 100ns, t_r = 2ns$ , averaging window from 60ns to 80ns.  $R_{DYN}$  is calculated from 4A to 16A.

(2). Contact discharge mode, according to IEC61000-4-2.

(3). Non-repetitive current pulse, according to IEC61000-4-5.

## ■Ordering Information (Example)

PREFERED P/N	UNIT WEIGHT(mg)	MINIMUM PACKAGE (pcs)	INNER BOX QUANTITY(pcs)	OUTER CARTON QUANTITY(pcs)	DELIVERY MODE
ESD4V5LBA	Approximate 0.9	10000	100000	400000	Tape & reel



## ■ Characteristics (Typical)

### 8/20 $\mu$ s waveform per IEC61000-4-5

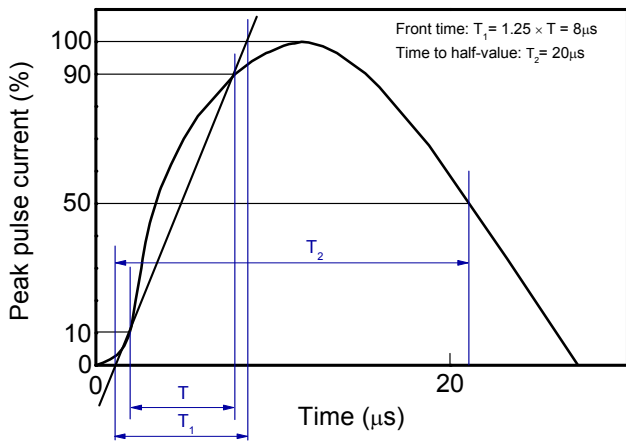

### Contact discharge current waveform per IEC61000-4-2

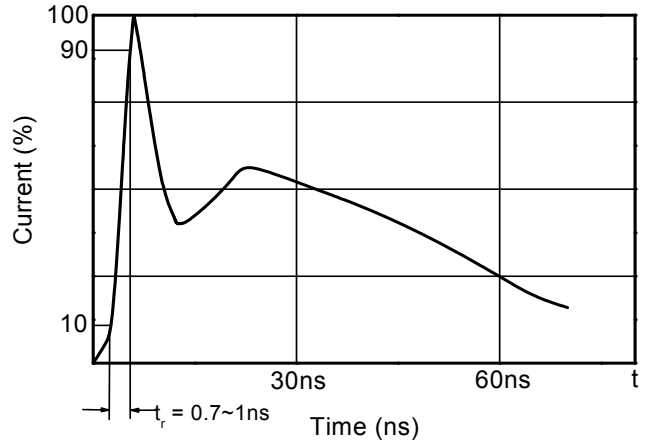

### Clamping voltage vs. Peak pulse current

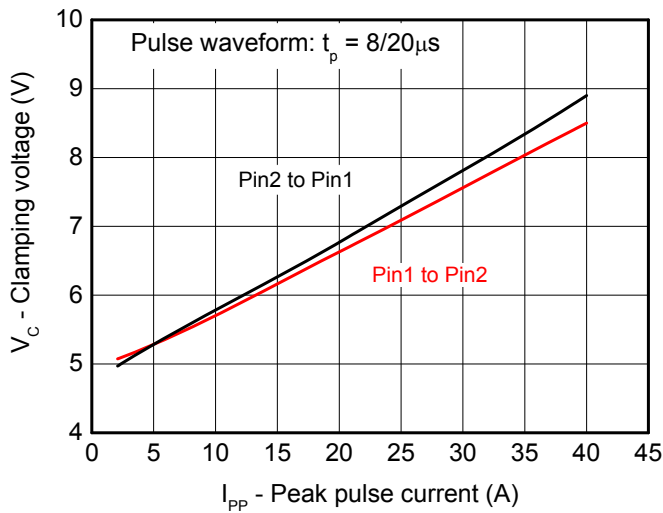

### Capacitance vs. Reverse voltage

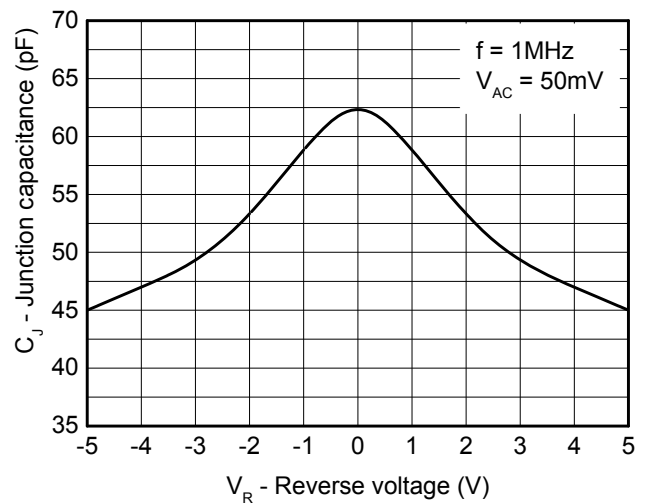

### Non-repetitive peak pulse power vs. Pulse time

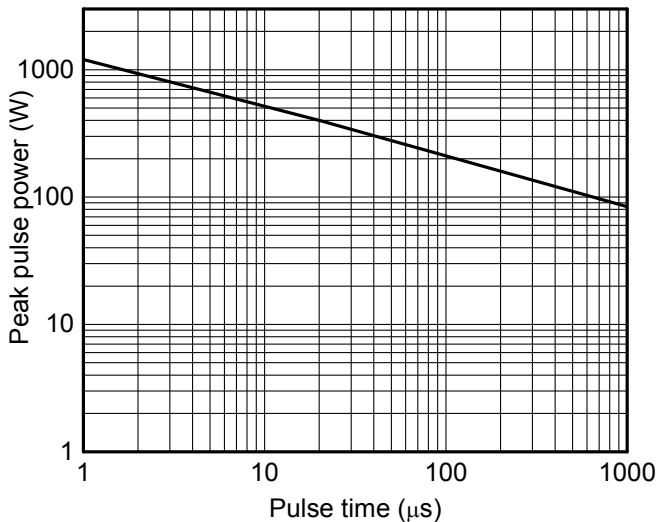

### Power derating vs. Ambient temperature

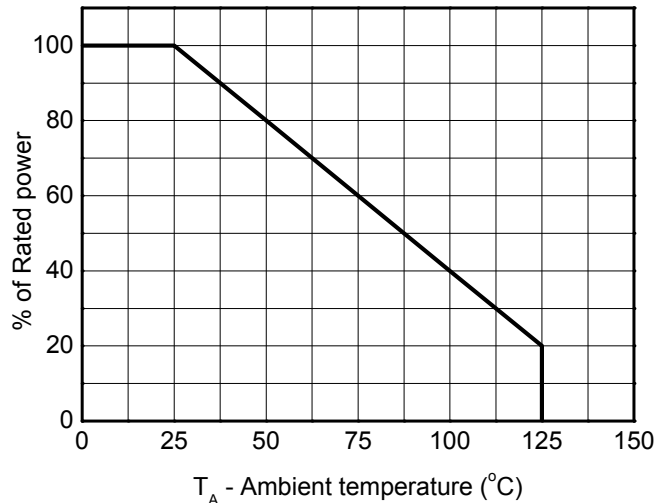

**ESD clamping**  
(+8kV contact discharge per IEC61000-4-2)

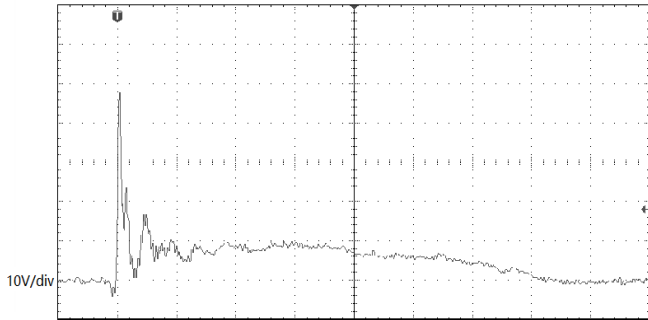

**ESD clamping**  
(-8kV contact discharge per IEC61000-4-2)

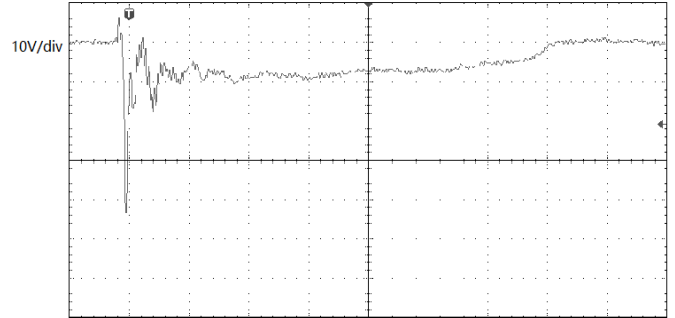

**TLP Measurement**

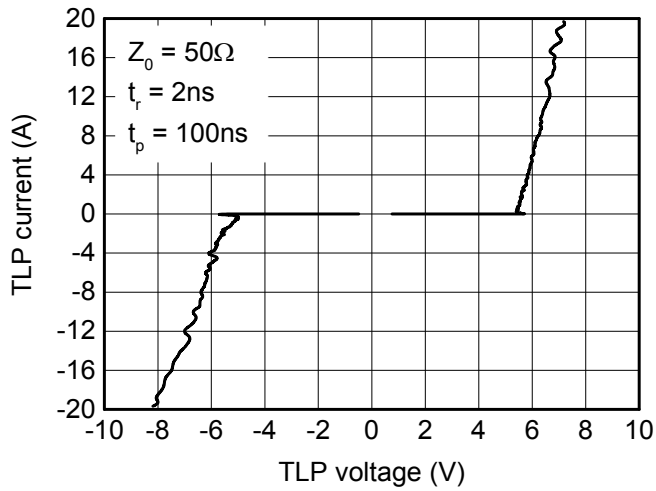

## ■ Outline Dimensions

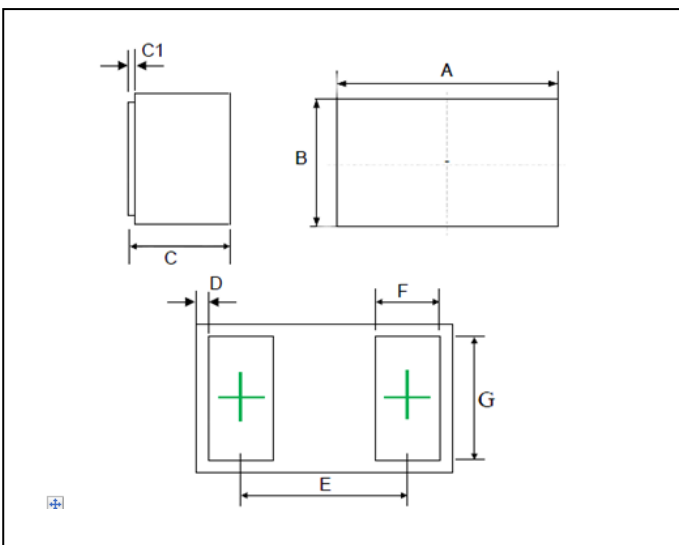

Symbol	min. (mm)	Max. (mm)
A	0.95	1.05
B	0.55	0.65
C	0.4	0.5
C1		0.05
D	0.01	0.08
E		0.65
F	0.2	0.3
G	0.45	0.55



## ■ Recommend land pattern (Unit:mm)

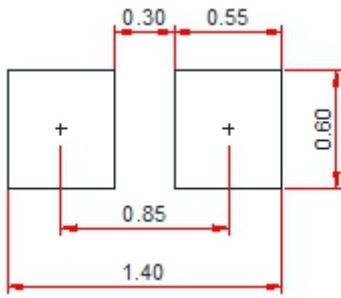

### Notes:

This recommended land pattern is for reference purposes only. Please consult your manufacturing group to ensure your PCB design guidelines are met



## ESD4V5LBA

---

### Disclaimer

The information presented in this document is for reference only. Yangzhou Yangjie Electronic Technology Co., Ltd. reserves the right to make changes without notice for the specification of the products displayed herein to improve reliability, function or design or otherwise.

The product listed herein is designed to be used with ordinary electronic equipment or devices, and not designed to be used with equipment or devices which require high level of reliability and the malfunction of which would directly endanger human life (such as medical instruments, transportation equipment, aerospace machinery, nuclear-reactor controllers, fuel controllers and other safety devices), Yangjie or anyone on its behalf, assumes no responsibility or liability for any damages resulting from such improper use of sale.

This publication supersedes & replaces all information previously supplied. For additional information, please visit our website [http:// www.21yangjie.com](http://www.21yangjie.com) , or consult your nearest Yangjie's sales office for further assistance.