

IGBT Discrete

V_{CE}	1200	V
I_C	40	A
$V_{CE(SAT)} I_C=40A$	1.65	V

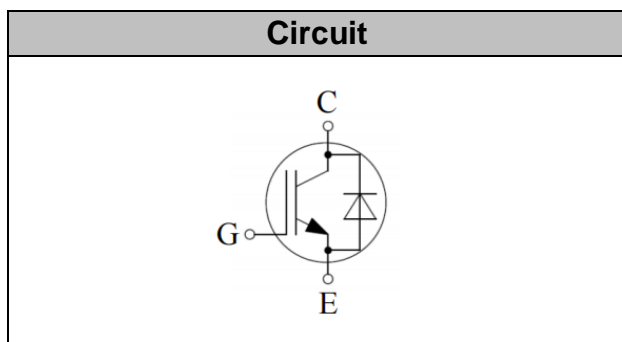

Applications

- EV-Charging
- String inverter
- Uninterruptible power supply
- Welding converters

Features

- High breakdown voltage to 1200V for improved reliability
- Maximum junction temperature 175°C
- Positive temperature coefficient
- Including fast & soft recovery anti-parallel FWD

Maximum Ratings

Parameter	Symbol	Value	Unit
Collector-Emitter Breakdown Voltage	V_{CE}	1200	V
DC Collector Current, limited by T_{jmax} $T_C=25^\circ C$ $T_C=100^\circ C$	I_C	80 40	A
Diode Forward Current, limited by T_{jmax} $T_C=25^\circ C$ $T_C=100^\circ C$	I_F	80 40	A
Continuous Gate-Emitter Voltage	V_{GE}	± 20	V
Transient Gate-Emitter Voltage ($t_p \leq 10\mu s, D < 0.010$)	V_{GE}	± 30	V
Turn off Safe Operating Area $V_{CE} \leq 1200V$, $T_j \leq 150^\circ C$		120	A
Pulsed Collector Current, $V_{GE}=15V$, t_p limited by T_{jmax}	I_{CM}	120	A
Diode Pulsed Current, t_p limited by T_{jmax}	I_{Fpuls}	120	A
Power Dissipation, $T_j=175^\circ C$, $T_C=25^\circ C$	P_{tot}	288	W



Operating Junction Temperature	T_j	-40...+175	°C
Storage Temperature	T_s	-55...+150	°C
Soldering Temperature, wave soldering 1.6mm (0.063in.) from case for 10s		260	°C

Electrical Characteristics of the IGBT ($T_j = 25^\circ\text{C}$ unless otherwise specified):

Parameter	Symbol	Conditions	Min.	Typ.	Max.	Unit
Static						
Collector-Emitter Breakdown Voltage	BV_{CES}	$V_{GE}=0V, I_C=250\mu A$	1200		-	V
Gate Threshold Voltage	$V_{GE(th)}$	$V_{GE}=V_{CE}, I_C=1mA$	5.0	5.8	6.6	V
Collector-Emitter Saturation Voltage	$V_{CE(sat)}$	$V_{GE}=15V, I_C=40A$ $T_j=25^\circ\text{C}$, $T_j=125^\circ\text{C}$ $T_j=150^\circ\text{C}$		1.65 1.95 2.05	1.95	V
Zero Gate Voltage Collector Current	I_{CES}	$V_{CE}=1200V, V_{GE}=0V$ $T_j=25^\circ\text{C}$, $T_j=150^\circ\text{C}$			0.25 4	mA
Gate-Emitter Leakage Current	I_{GES}	$V_{CE}=0V, V_{GE}=\pm 20V$			100	nA

Parameter	Symbol	Conditions	Min.	Typ.	Max.	Unit
Dynamic						
Input Capacitance	C_{ies}	$V_{CE}=25V, V_{GE}=0V,$ $f=1\text{MHz}$	-	5.06	-	nF
Reverse Transfer Capacitance	C_{res}		-	0.04	-	
Gate Charge	Q_G	$V_{CC}=960V, I_C=40A,$ $V_{GE}=15V$	-	0.12	-	uC

**Electrical Characteristics of the Diode** ($T_j = 25^\circ\text{C}$ unless otherwise specified):

Parameter	Symbol	Conditions	Min.	Typ.	Max.	Unit
Static						
Diode Forward Voltage	V_F	$I_F = 40\text{A}$ $T_j = 25^\circ\text{C}$, $T_j = 125^\circ\text{C}$ $T_j = 150^\circ\text{C}$		2.20 2.00 1.90	2.70	V

Switching Characteristic, Inductive Load

Parameter	Symbol	Conditions	Min.	Typ.	Max.	Unit
Dynamic , at $T_j = 25^\circ\text{C}$						
Turn-on Delay Time	$t_{d(on)}$	$V_{CC} = 600\text{V}$, $I_C = 40\text{A}$, $V_{GE} = -5\text{V} \sim 15\text{V}$, $R_g = 10\Omega$	-	56	-	ns
Rise Time	t_r		-	31	-	ns
Turn-on Energy	E_{on}		-	2.29	-	mJ
Turn-off Delay Time	$t_{d(off)}$		-	192	-	ns
Fall Time	t_f		-	69	-	ns
Turn-off Energy	E_{off}		-	1.12	-	mJ
Dynamic , at $T_j = 125^\circ\text{C}$						
Turn-on Delay Time	$t_{d(on)}$	$V_{CC} = 600\text{V}$, $I_C = 40\text{A}$, $V_{GE} = -5\text{V} \sim 15\text{V}$, $R_g = 10\Omega$	-	58	-	ns
Rise Time	t_r		-	32	-	ns
Turn-on Energy	E_{on}		-	2.32	-	mJ
Turn-off Delay Time	$t_{d(off)}$		-	201	-	ns
Fall Time	t_f		-	77	-	ns
Turn-off Energy	E_{off}		-	1.22	-	mJ
Dynamic , at $T_j = 150^\circ\text{C}$						
Turn-on Delay Time	$t_{d(on)}$	$V_{CC} = 600\text{V}$, $I_C = 40\text{A}$, $V_{GE} = -5\text{V} \sim 15\text{V}$, $R_g = 10\Omega$	-	59	-	ns
Rise Time	t_r		-	33	-	ns
Turn-on Energy	E_{on}		-	2.33	-	mJ
Turn-off Delay Time	$t_{d(off)}$		-	206	-	ns
Fall Time	t_f		-	83	-	ns
Turn-off Energy	E_{off}		-	1.26	-	mJ



Electrical Characteristics of the DIODE

Parameter	Symbol	Conditions	Min.	Typ.	Max.	Unit
Dynamic , at T_j= 25°C						
Reverse Recovery Current	I _{rr}	I _F =40A, V _R =600V, di/dt= -500A/μs	-	11	-	A
Diode reverse recovery time	trr		-	225	-	ns
Reverse Recovery Charge	Q _{rr}		-	1.29	-	uC
Reverse Recovery Energy	E _{rec}		-	0.33	-	mJ
Dynamic , at T_j= 125°C						
Reverse Recovery Current	I _{rr}	I _F =40A, V _R =600V, di/dt= -500A/μs	-	15	-	A
Diode reverse recovery time	trr		-	315	-	ns
Reverse Recovery Charge	Q _{rr}		-	3.58	-	uC
Reverse Recovery Energy	E _{rec}		-	1.07	-	mJ
Dynamic , at T_j= 150°C						
Reverse Recovery Current	I _{rr}	I _F =40A, V _R =600V, di/dt= -500A/μs	-	16	-	A
Diode reverse recovery time	trr		-	344	-	ns
Reverse Recovery Charge	Q _{rr}		-	4.11	-	uC
Reverse Recovery Energy	E _{rec}		-	1.23	-	mJ

Thermal Resistance

Parameter	Symbol	Max. Value	Unit
IGBT Thermal Resistance, Junction - Case	R _{θ(j-c)}	0.52	K/W
Diode Thermal Resistance, Junction - Case	R _{θ(j-c)}	0.65	K/W
Thermal Resistance, Junction - Ambient	R _{θ(j-a)}	40	K/W

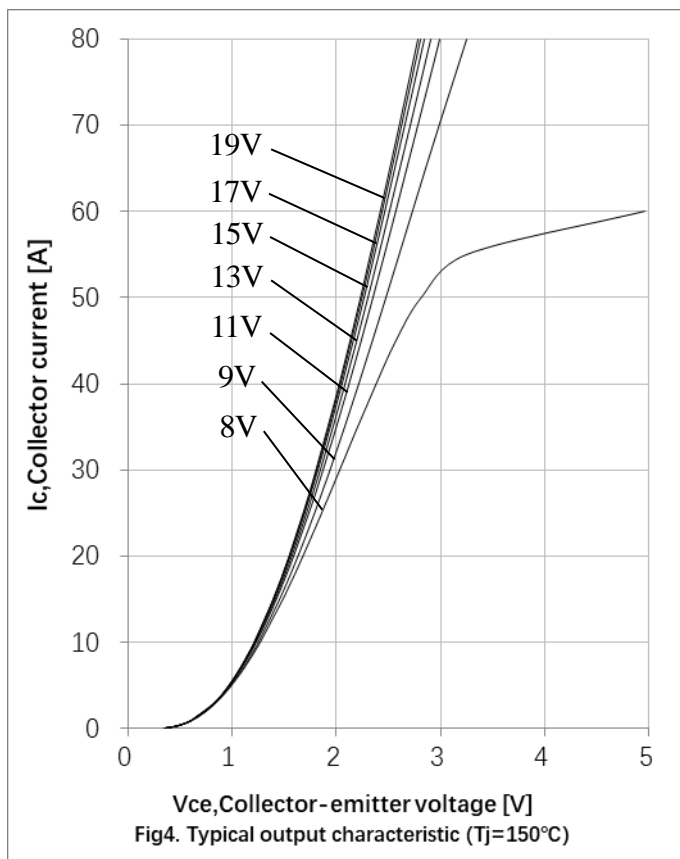
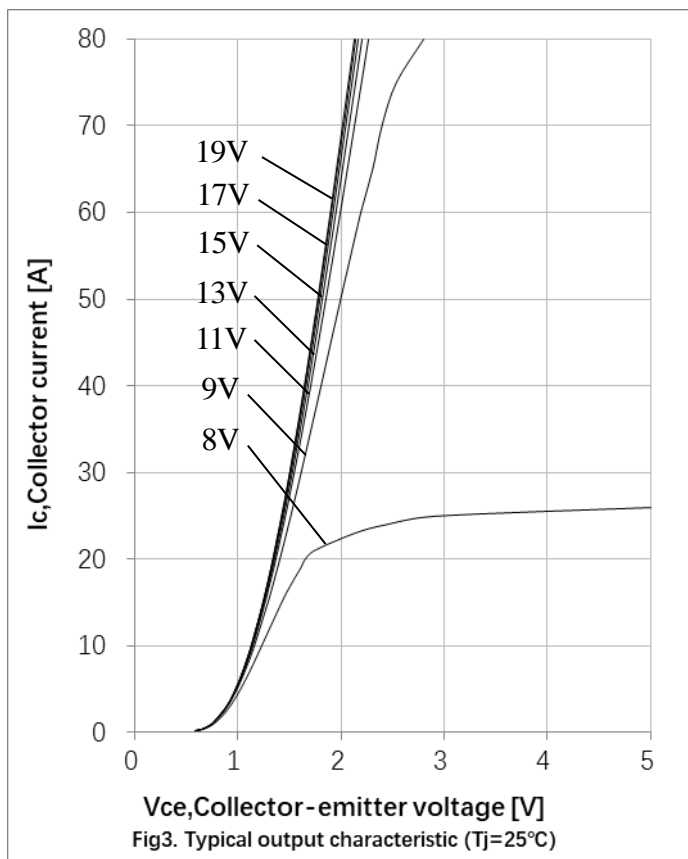
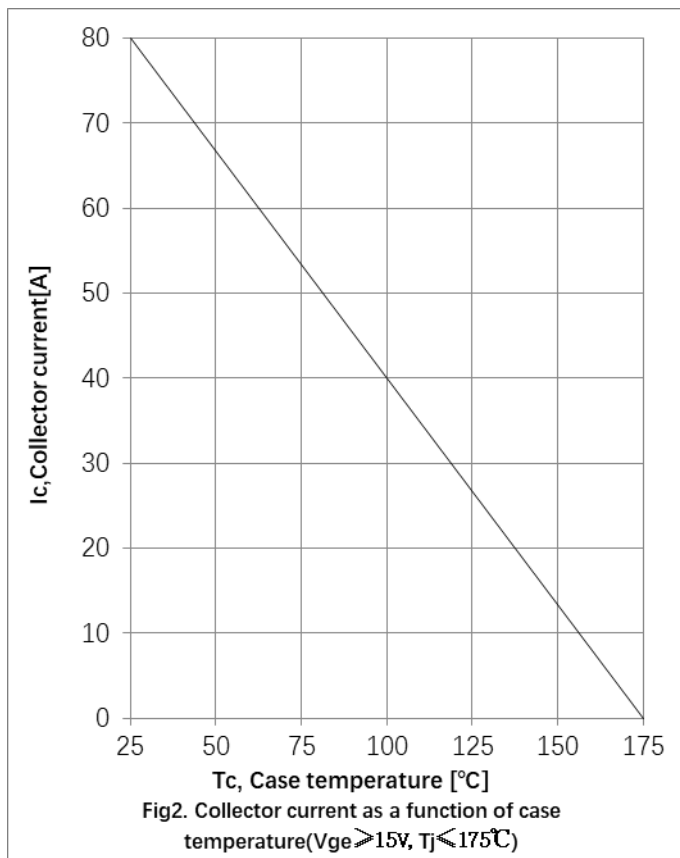
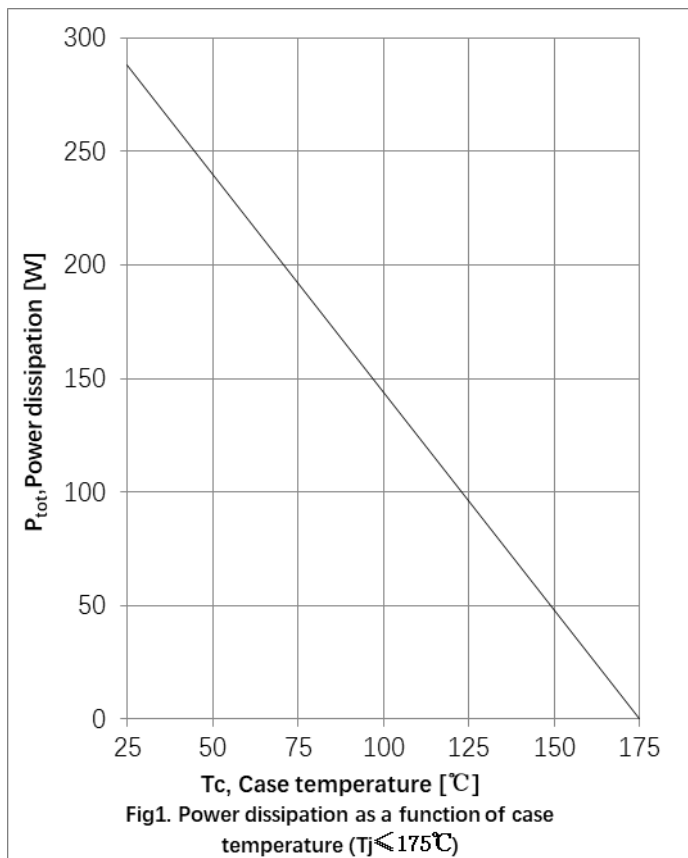

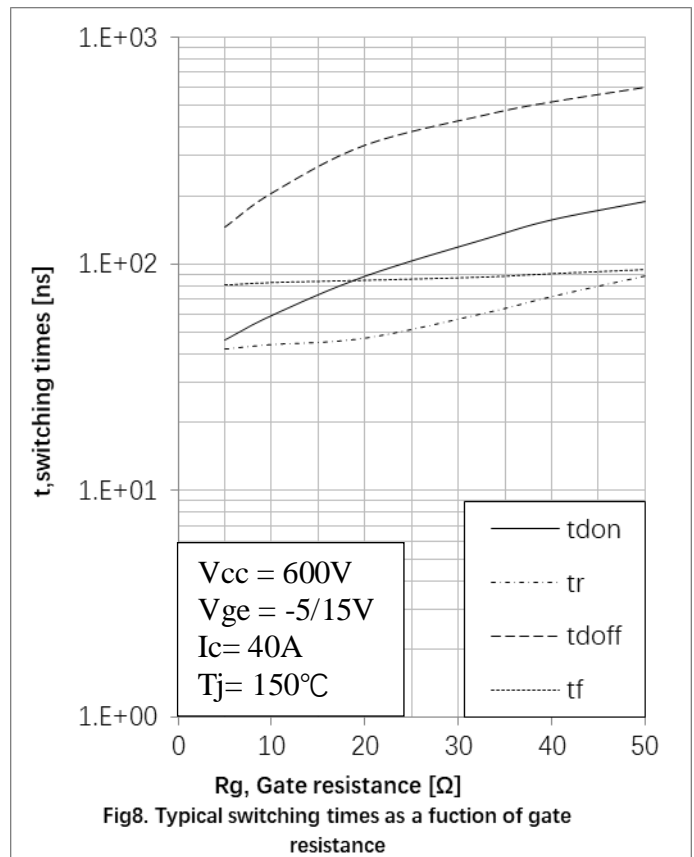
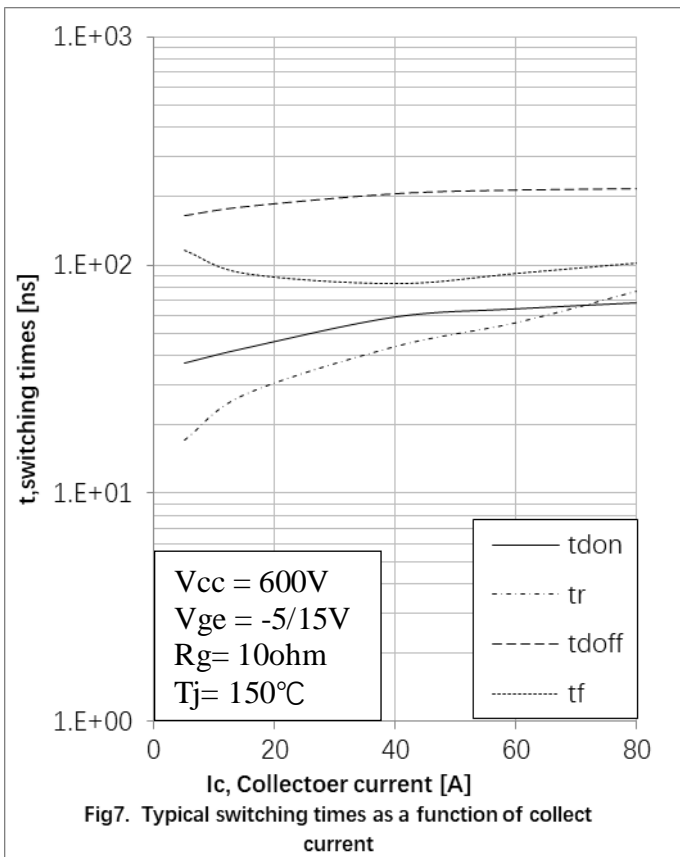
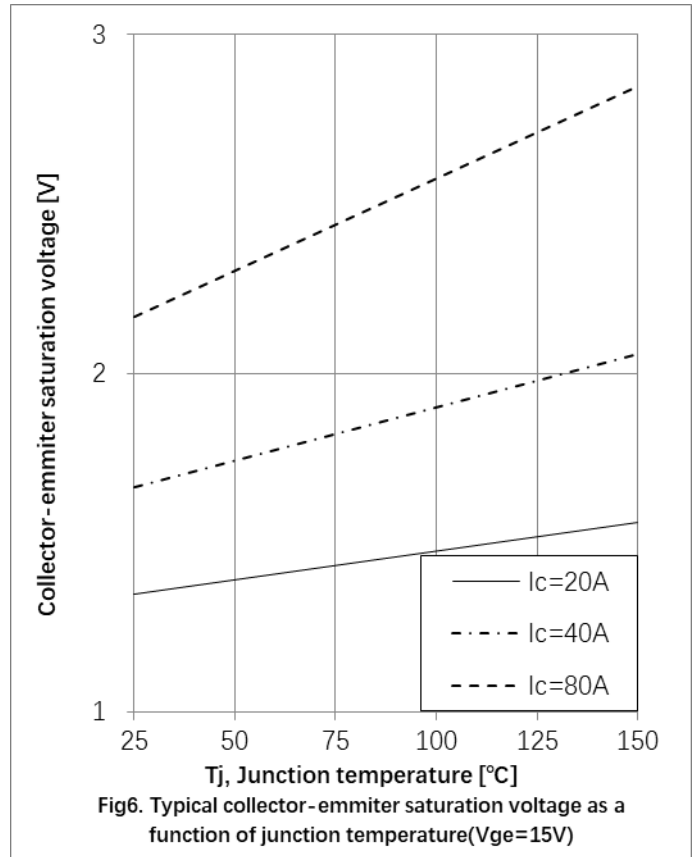
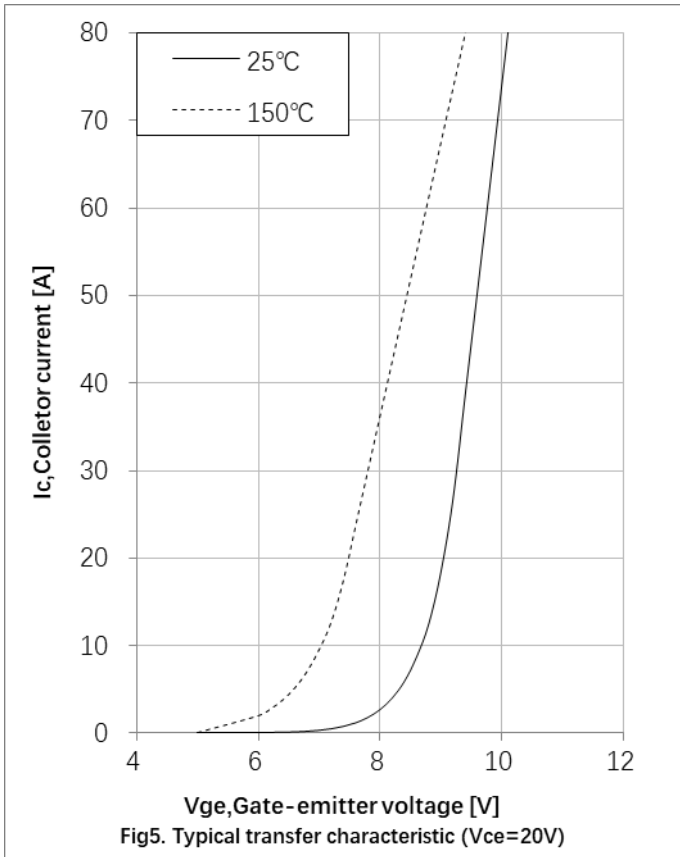

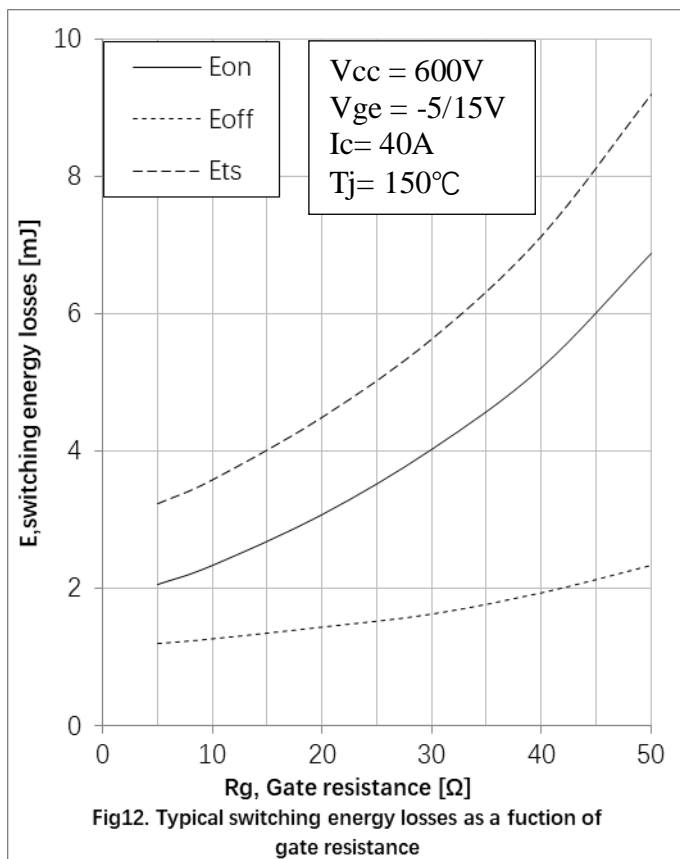
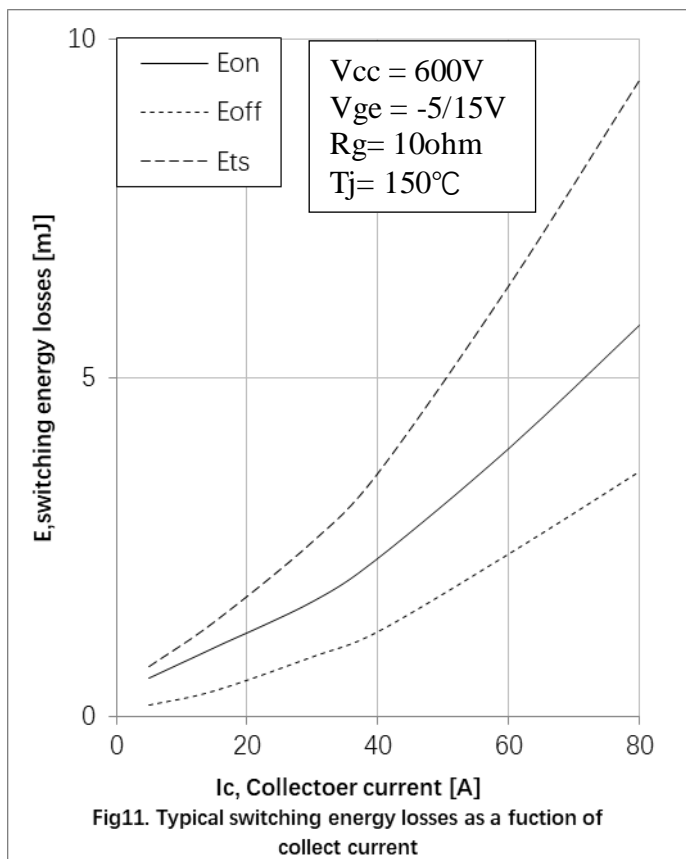
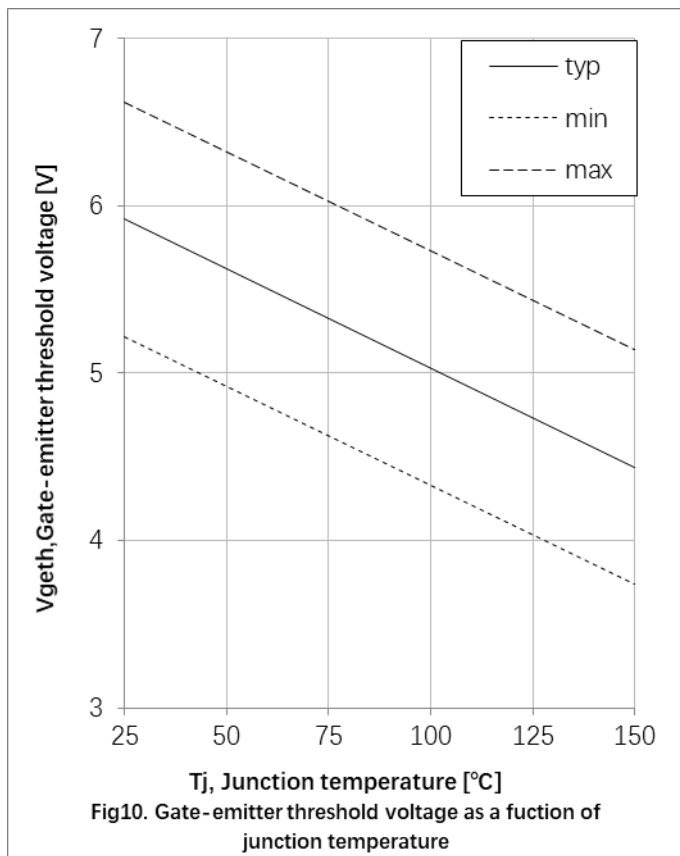
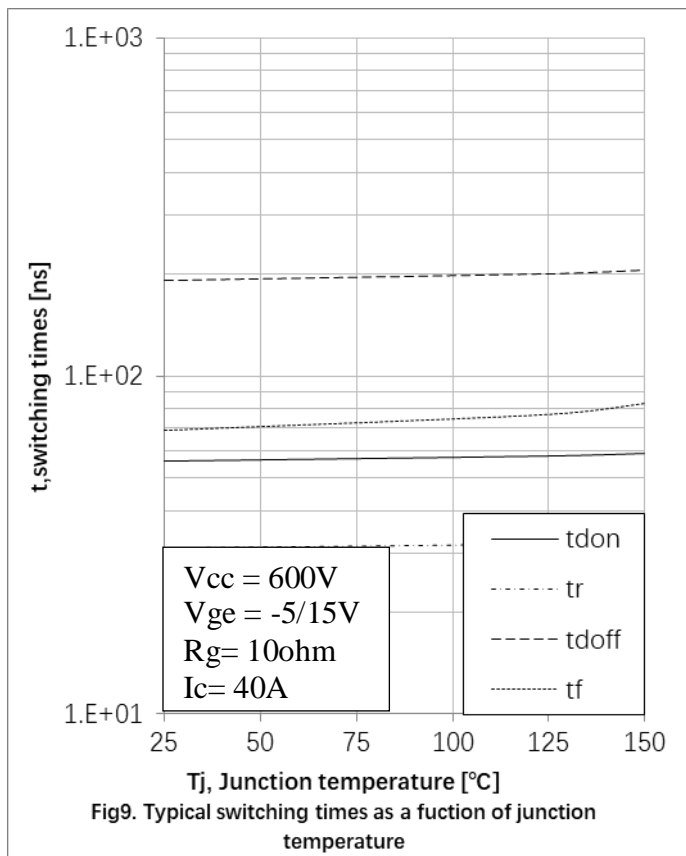

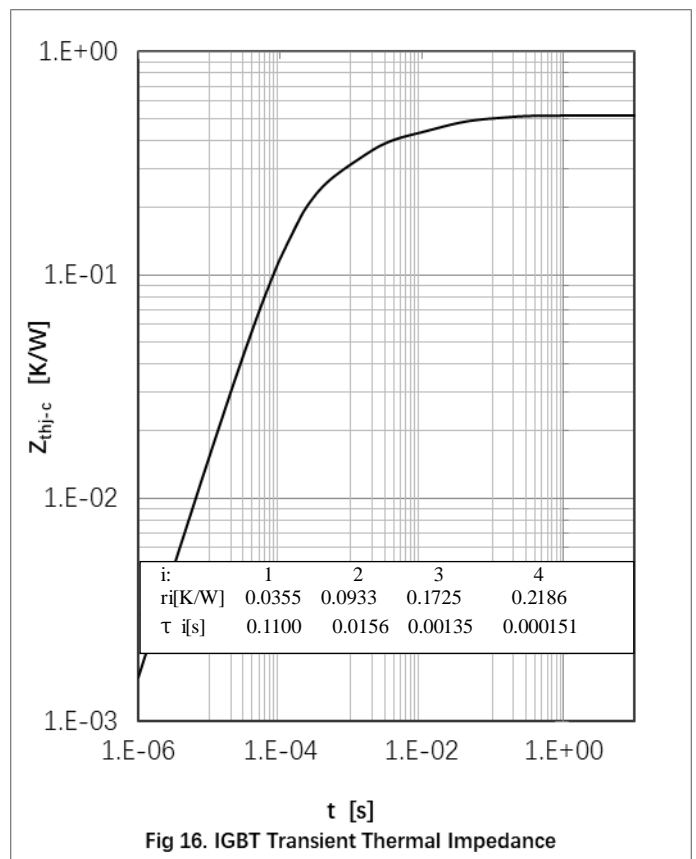
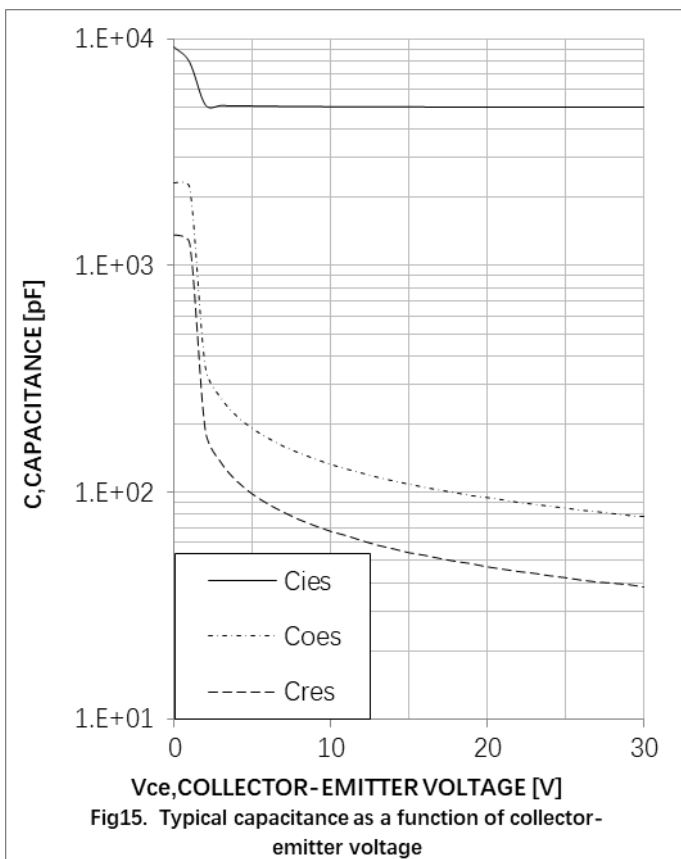
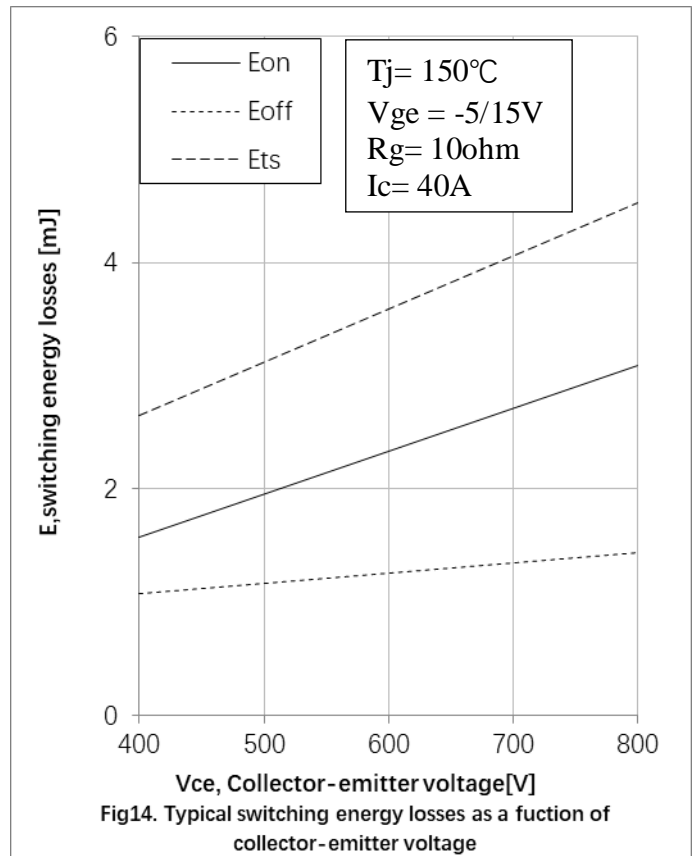
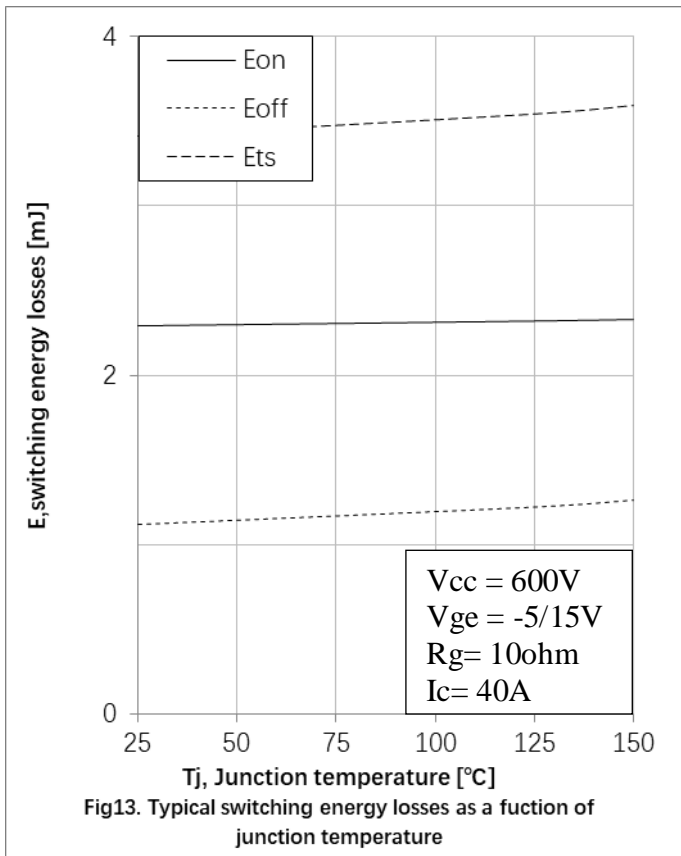

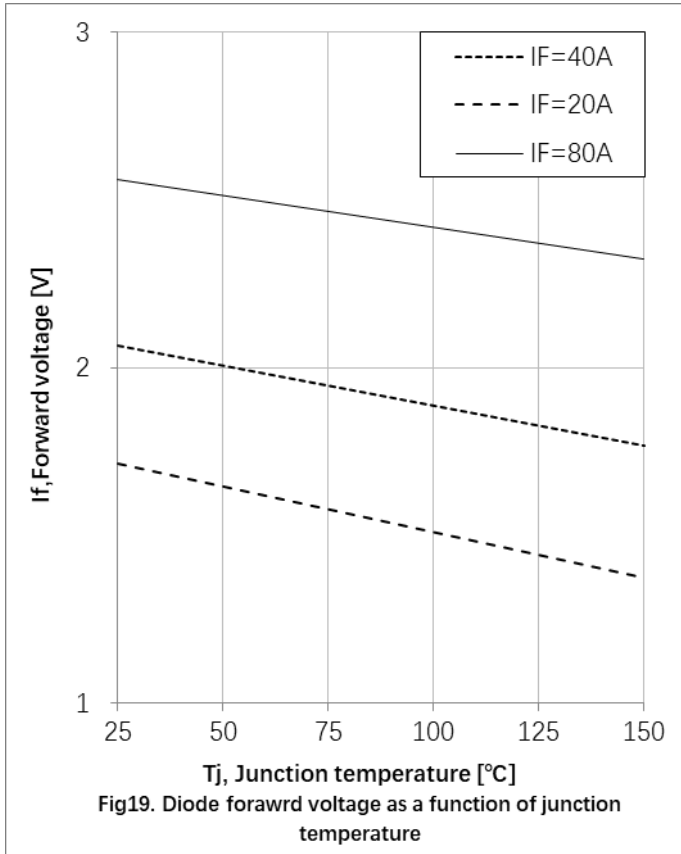
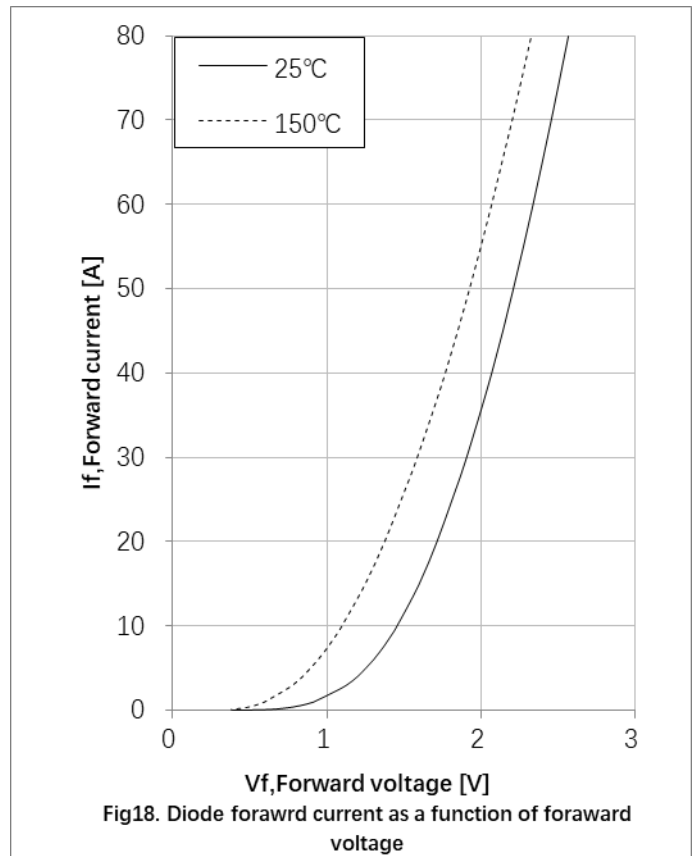
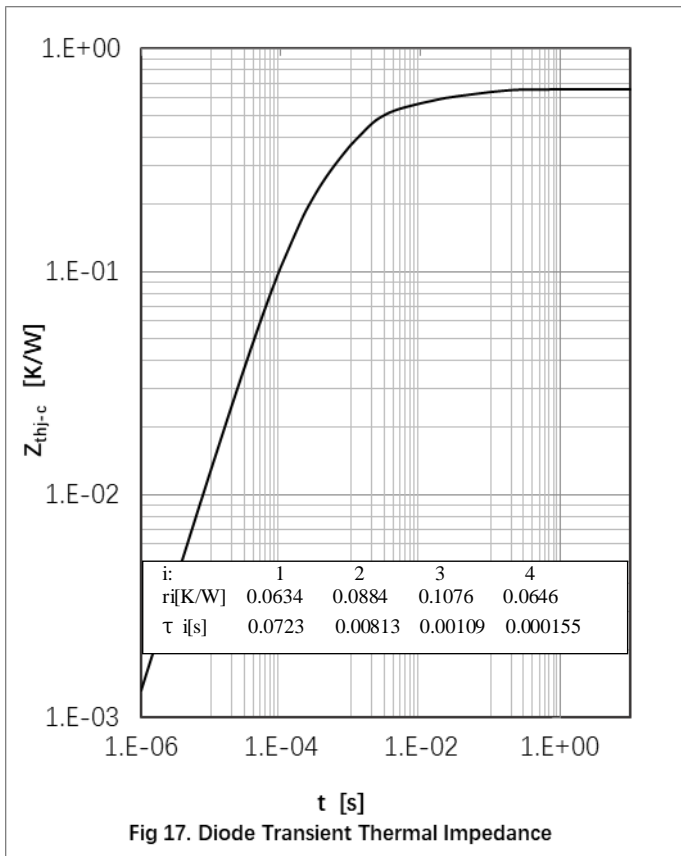

● **Circuit Diagram**

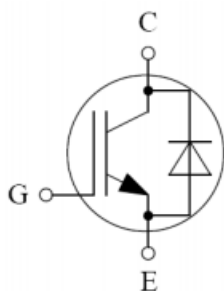

● **Package Outline Information**

CASE: TO 247

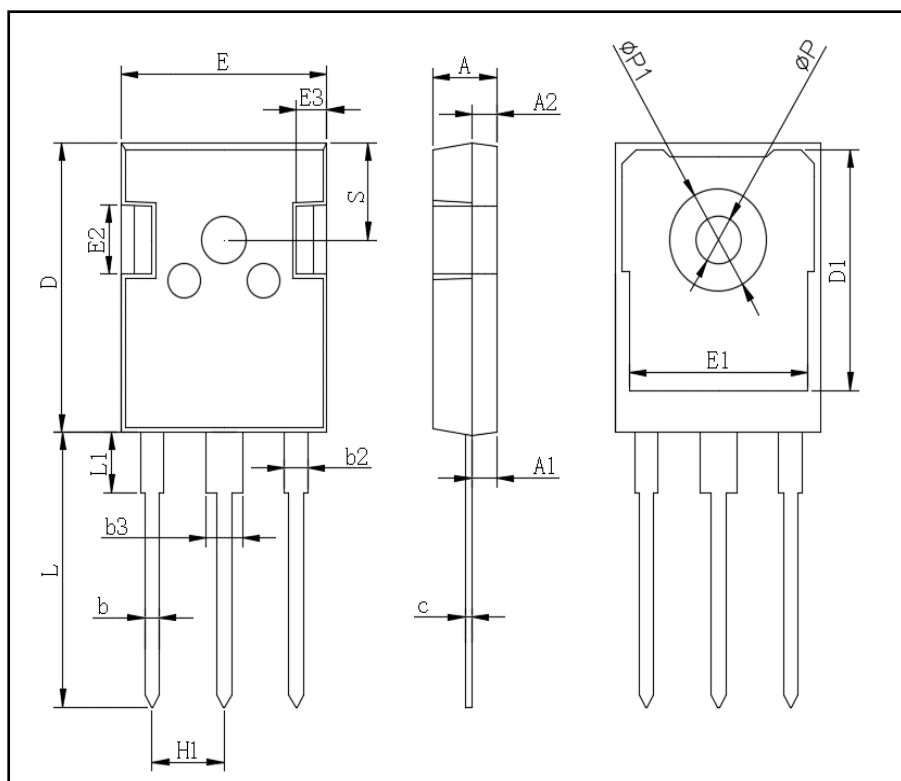

TO-247AB		
Dim	Min	Max
A	4.80	5.20
A1	2.21	2.61
A2	1.85	2.15
b	1.0	1.4
b2	1.91	2.21
C	0.5	0.7
D	20.70	21.30
D1	16.25	16.85
E	15.50	16.10
E1	13.0	13.6
E2	4.80	5.20
E3	2.30	2.70
L	19.62	20.22
L1	-	4.30
ϕP	3.40	3.80
$\phi P1$	-	7.30
S	6.15TYP	
H1	5.44TYP	
b3	2.80	3.20