



FRED Modules

V_{RRM} 1200V

I_{FAV} 200 A

Applications

- Inversion Welder
- Uninterruptible Power Supply (UPS)
- Plating Power Supply
- Ultrasonic Cleaner and Welder
- Power Factor Correction (PFC) Circuit
- Converter & Chopper

Features

- Soft Reverse Recovery Characteristics
- Ultrafast Reverse Recovery Time
- Low Reverse Recovery Loss
- Low Forward Voltage
- High Surge Current Capability
- Low Inductance Package

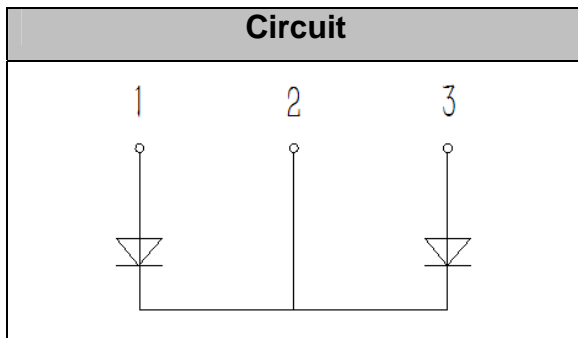

Maximum Ratings

| Symbol | Conditions | Values | Units |
|---------------------|---|-------------|------------------|
| V _R | | 1200 | V |
| V _{RRM} | | 1200 | V |
| I _{F(AV)} | T _C =110°C, Per Diode | 200 | A |
| I _{F(RMS)} | T _C =110°C, Per Diode | 280 | A |
| I _{FSM} | 1/2 Cycle, 50Hz, Sine | 1800 | A |
| | 1/2 Cycle, 60Hz, Sine | 1950 | A |
| I ² t | T _J =45°C, t=10ms, 50Hz, Sine | 16200 | A ² s |
| | T _J =45°C, t=8.3ms, 60Hz, Sine | 19000 | A ² s |
| P _D | | 568 | W |
| Visol | AC, Ton=1min | 3000 | V |
| T _J | | -40 to +150 | °C |
| T _{STG} | | -40 to +125 | °C |
| Torque | Recommended (M6) | 4.5 | N·m |
| Torque | Recommended (M6) | 4.5 | N·m |
| Weight | | 160 | g |

Thermal Characteristics

| Symbol | Conditions | Values | Units |
|----------------------|------------------|--------|-------|
| R _{th(j-c)} | Junction-to-Case | 0.22 | °C/W |



Electrical Characteristics

| Symbol | Conditions | Values | | | Units |
|-----------|--|--------|------|------|-------|
| | | Min. | Typ. | Max. | |
| I_{RM} | $V_R=1200V$ | -- | -- | 1 | mA |
| | $V_R=1200V, T_J=125^\circ C$ | -- | -- | 5 | mA |
| V_F | $I_F=200A$ | -- | 2.3 | | V |
| | $I_F=200A, T_J=125^\circ C$ | -- | 1.9 | | V |
| t_{rr} | $I_F=1A, V_R=30V, di_F/dt=-200A/\mu s$ | -- | 57 | -- | ns |
| t_{rr} | $V_R=600V, I_F=200A, di_F/dt=-200A/\mu s, T_J=25^\circ C$ | -- | 110 | -- | ns |
| I_{RRM} | | -- | 9 | -- | A |
| t_{rr} | $V_R=600V, I_F=200A, di_F/dt=-200A/\mu s, T_J=125^\circ C$ | -- | 500 | -- | ns |
| I_{RRM} | | -- | 21 | -- | A |

Performance Curves

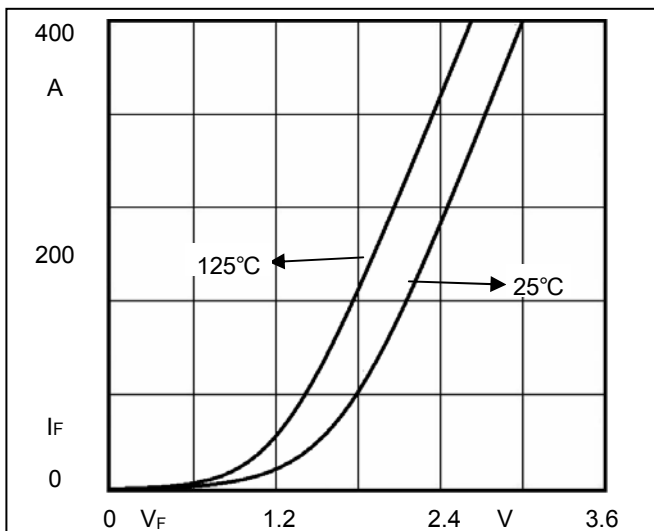

Fig1. Forward Voltage Drop vs Forward Current

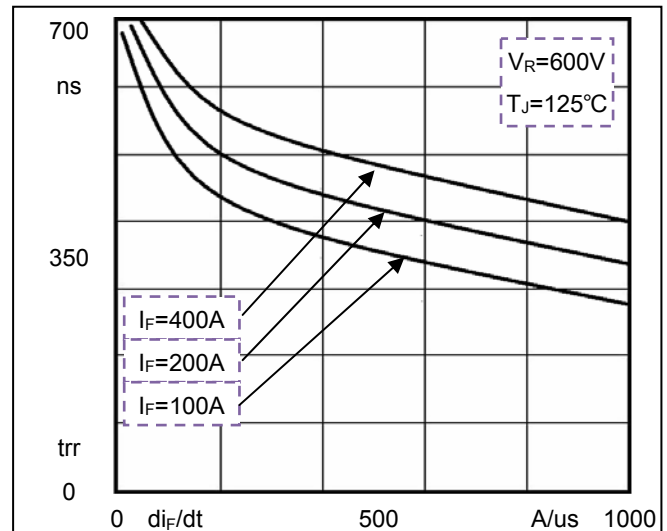

Fig2. Reverse Recovery Time vs di_F/dt

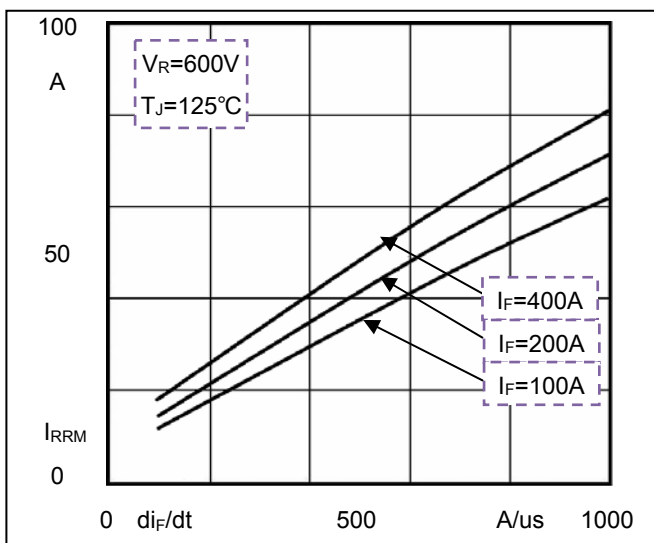

Fig3. Reverse Recovery Current vs di_F/dt

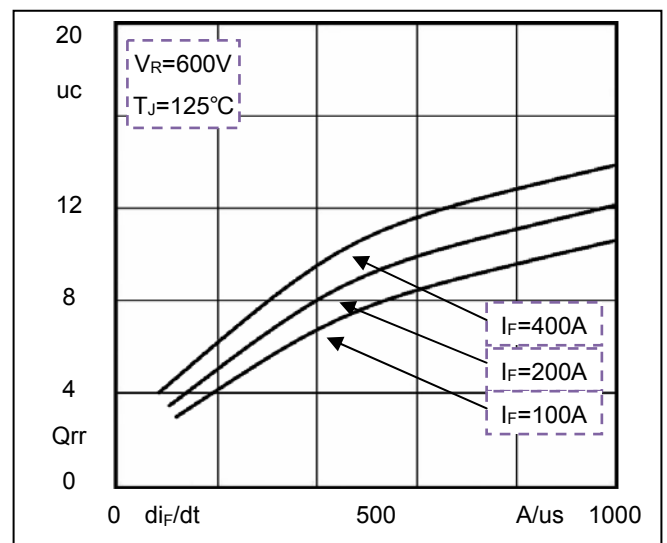
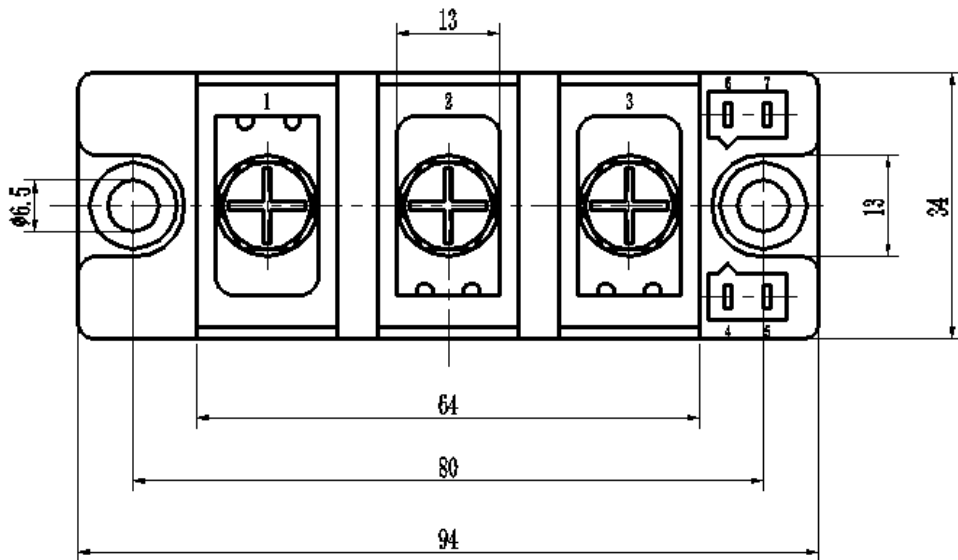
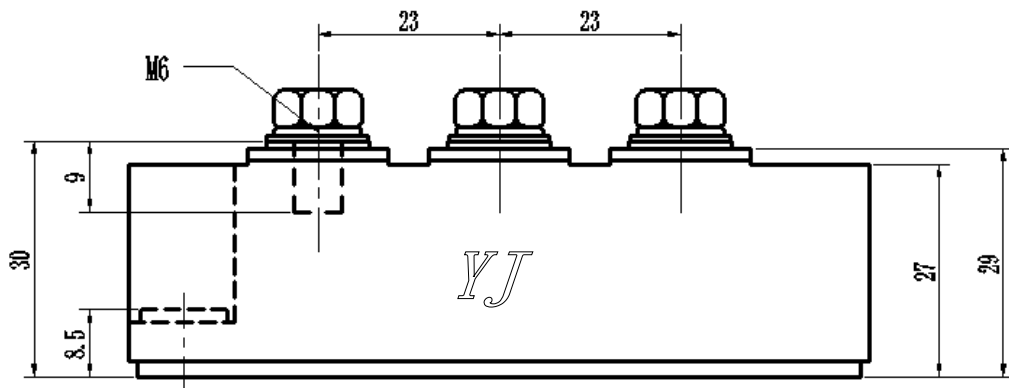

Fig4. Reverse Recovery Charge vs di_F/dt

Package Outline Information

CASE: F2N



Dimensions in mm