

P-Channel Enhancement Mode Field Effect Transistor

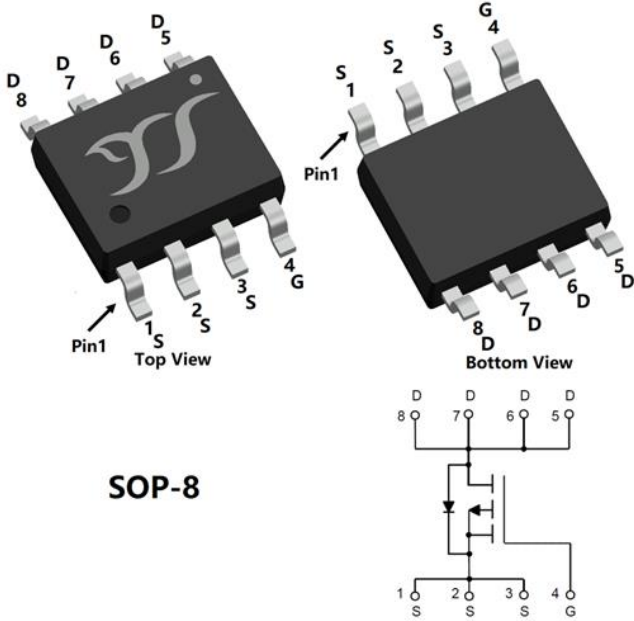

SOP-8

Product Summary

- V_{DS} -60V
- I_D -5.9A
- $R_{DS(ON)}$ (at $V_{GS}=-10V$) <47 mohm
- $R_{DS(ON)}$ (at $V_{GS}=-4.5V$) <60 mohm
- 100% EAS Tested

General Description

- Split gate trench MOSFET technology
- High density cell design for low $R_{DS(ON)}$
- Low C_{rss}
- Epoxy Meets UL 94 V-0 Flammability Rating
- Halogen Free

Applications

- Load switch
- Battery protection

■ Absolute Maximum Ratings ($T_A=25^\circ C$ unless otherwise noted)

Parameter	Symbol	Limit	Unit
Drain-source Voltage	V_{DS}	-60	V
Gate-source Voltage	V_{GS}	± 20	V
Drain Current	I_D	$T_A=25^\circ C$	-5.9
		$T_A=100^\circ C$	-3.7
Pulsed Drain Current ^A	I_{DM}	-30	A
Avalanche energy ^B	EAS	81	mJ
Total Power Dissipation ^C	P_D	3.1	W
Junction and Storage Temperature Range	T_J, T_{STG}	-55~+150	$^\circ C$

■ Thermal resistance

Parameter	Symbol	Typ	Max	Units
Thermal Resistance Junction-to-Ambient ^D	$R_{\theta JA}$	31	40	$^\circ C/W$
Thermal Resistance Junction-to-Ambient ^D		Steady-State	59	
Thermal Resistance Junction-to-Lead	$R_{\theta JL}$	16	24	

■ Ordering Information (Example)

PREFERRED P/N	PACKING CODE	Marking	MINIMUM PACKAGE(pcs)	INNER BOX QUANTITY(pcs)	OUTER CARTON QUANTITY(pcs)	DELIVERY MODE
YJS06GP06A	F2	Q06GP06A	4000	8000	64000	13" reel



YJS06GP06A

■ Electrical Characteristics (T_J=25°C unless otherwise noted)

Parameter	Symbol	Conditions	Min	Typ	Max	Units
Static Parameter						
Drain-Source Breakdown Voltage	BV _{DSS}	V _{GS} =0V, I _D =-250μA	-60			V
Zero Gate Voltage Drain Current	I _{DSS}	V _{DS} =-60V, V _{GS} =0V	T _J =25°C		-1	μA
			T _J =55°C		-5	
Gate-Body Leakage Current	I _{GSS}	V _{GS} = ±20V, V _{DS} =0V			±100	nA
Gate Threshold Voltage	V _{GS(th)}	V _{DS} = V _{GS} , I _D =-250μA	-1.3	-1.8	-2.5	V
Static Drain-Source On-Resistance	R _{DS(on)}	V _{GS} = -10V, I _D =-6A		35	47	mΩ
		V _{GS} = -4.5V, I _D =-3A		45	60	
Gate Resistance	R _g	f=1MHz		12		Ω
Diode Forward Voltage	V _{SD}	I _S =-6A, V _{GS} =0V		-0.85	-1.3	V
Maximum Body-Diode Continuous Current	I _S				-6.0	A
Dynamic Parameters						
Input Capacitance	C _{iss}	V _{DS} =-30V, V _{GS} =0V, f=1MHz		1100		pF
Output Capacitance	C _{oss}			350		
Reverse Transfer Capacitance	C _{rss}			28		
Switching Parameters						
Total Gate Charge	Q _{g(-10V)}	V _{GS} =-10V, V _{DS} =-30V, I _D =-3A		18.7		nC
Total Gate Charge	Q _{g(-4.5V)}			8.8		
Gate-Source Charge	Q _{gs}			4.7		
Gate-Drain Charge	Q _{gd}			3.0		
Reverse Recovery Charge	Q _{rr}	I _F =-3A, di/dt=100A/us		8.2		nC
Reverse Recovery Time	t _{rr}			20.2		
Turn-on Delay Time	t _{D(on)}	V _{GS} =-10V, V _{DD} =-30V, I _{DS} =-3A R _{GEN} =6Ω		7.5		ns
Turn-on Rise Time	t _r			39.5		
Turn-off Delay Time	t _{D(off)}			43.6		
Turn-off fall Time	t _f			55.1		

A. Repetitive rating; pulse width limited by max. junction temperature.

B. V_{DD}=50V, R_G=25Ω, L=0.5mH, I_{AS}=18A.

C. Pd is based on max. junction temperature, using ≤10s junction-ambient thermal resistance.

D. The value of R_{θJA} is measured with the device mounted on 1in² FR-4 board with 2oz. Copper, in a still air environment with T_A=25°C. The value in any given application depends on the user's specific board design.



■ Typical Performance Characteristics

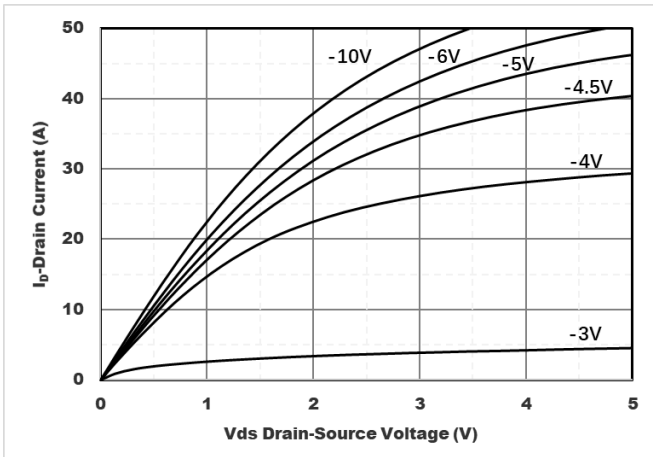

Figure1. Output Characteristics

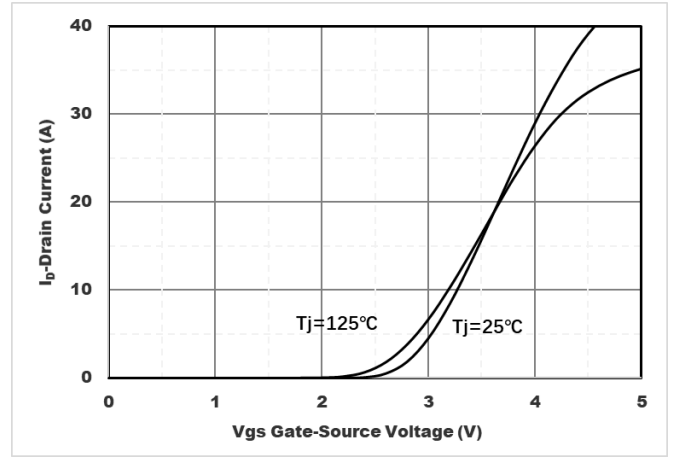

Figure2. Transfer Characteristics

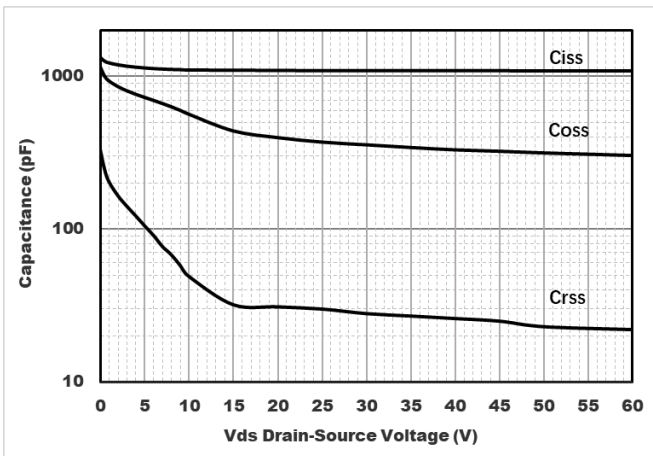

Figure3. Capacitance Characteristics

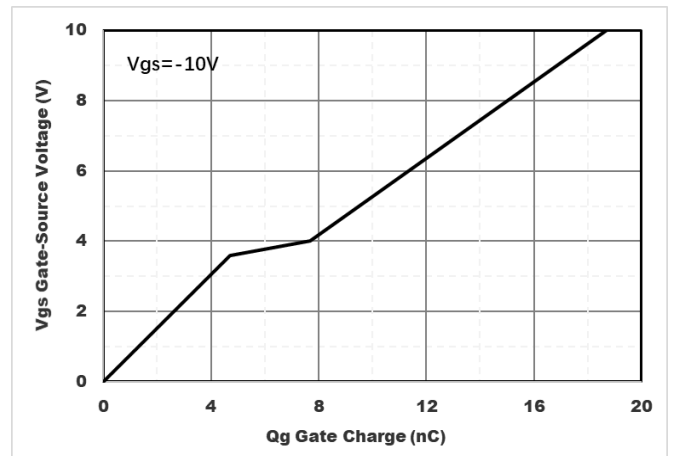

Figure4. Gate Charge

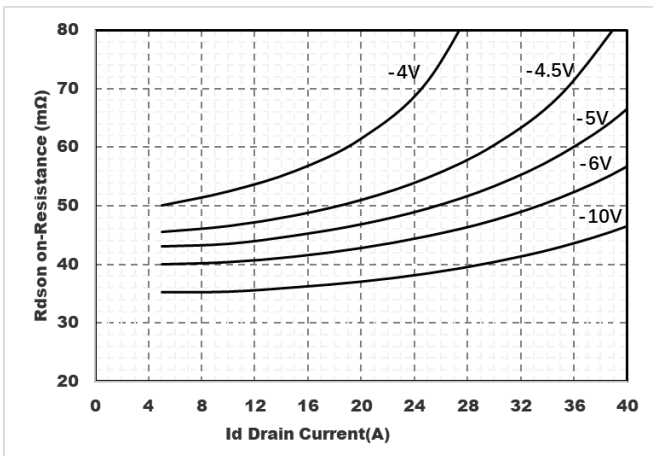

Figure5. : On-Resistance vs. Gate to Source Voltage

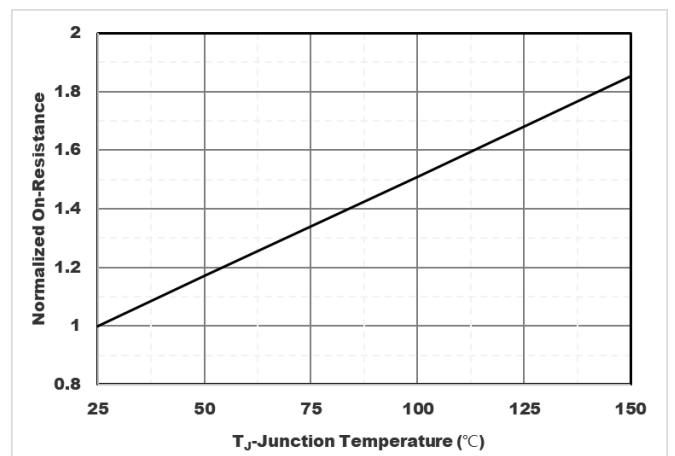

Figure6. Normalized On-Resistance



YJS06GP06A

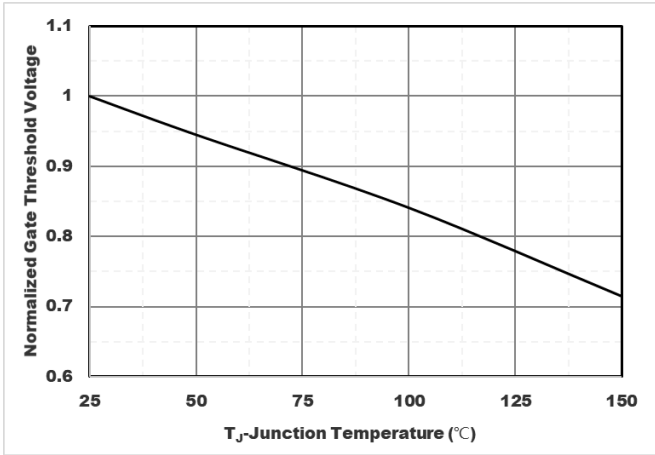

Figure 7. Normalized Gate Threshold Voltage

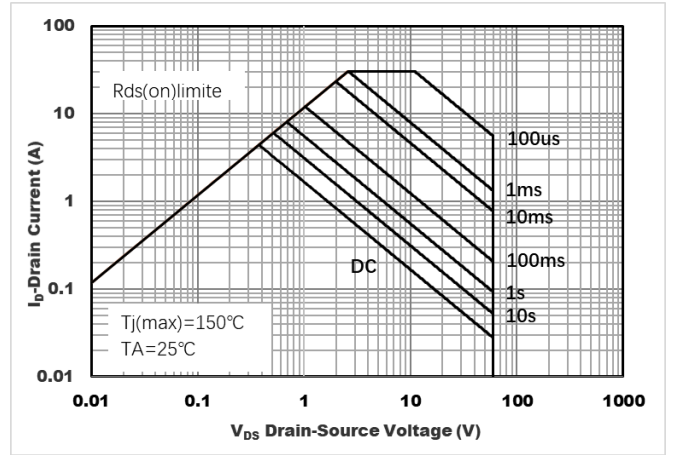

Figure 8. Safe Operation Area

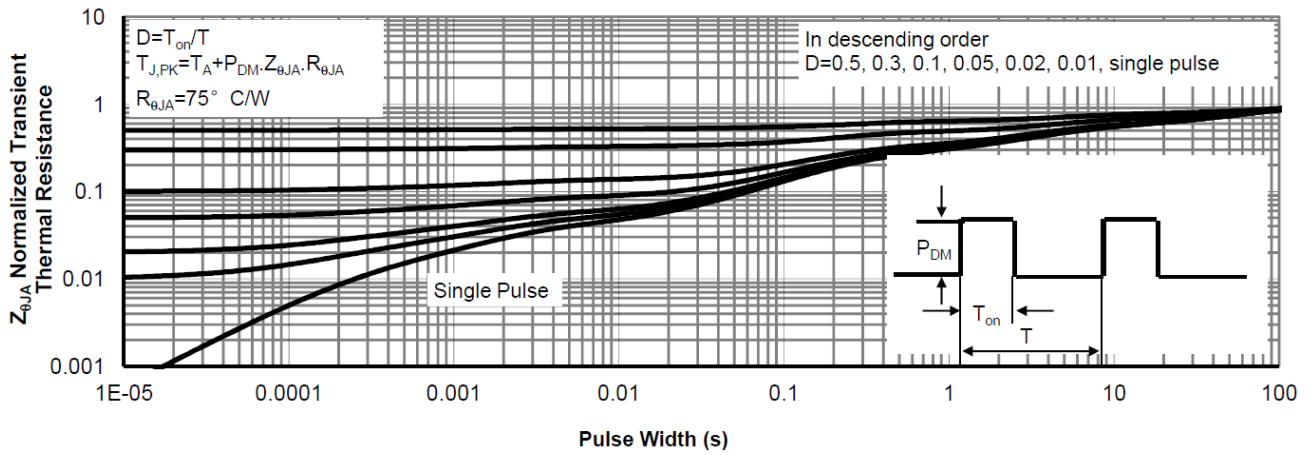

Figure 9. Normalized Maximum Transient Thermal Impedance

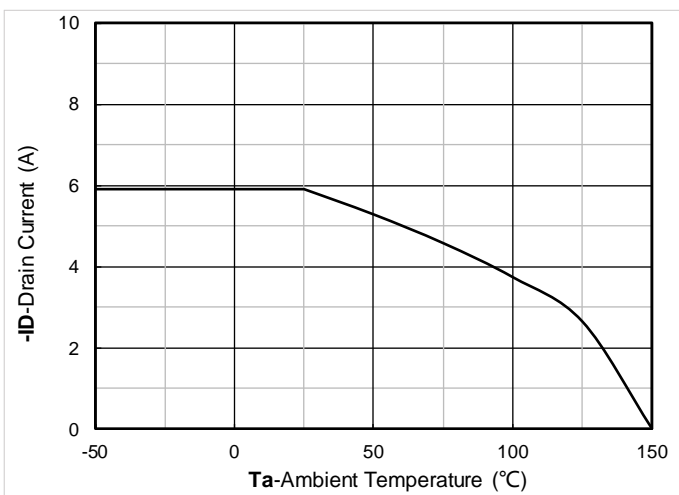
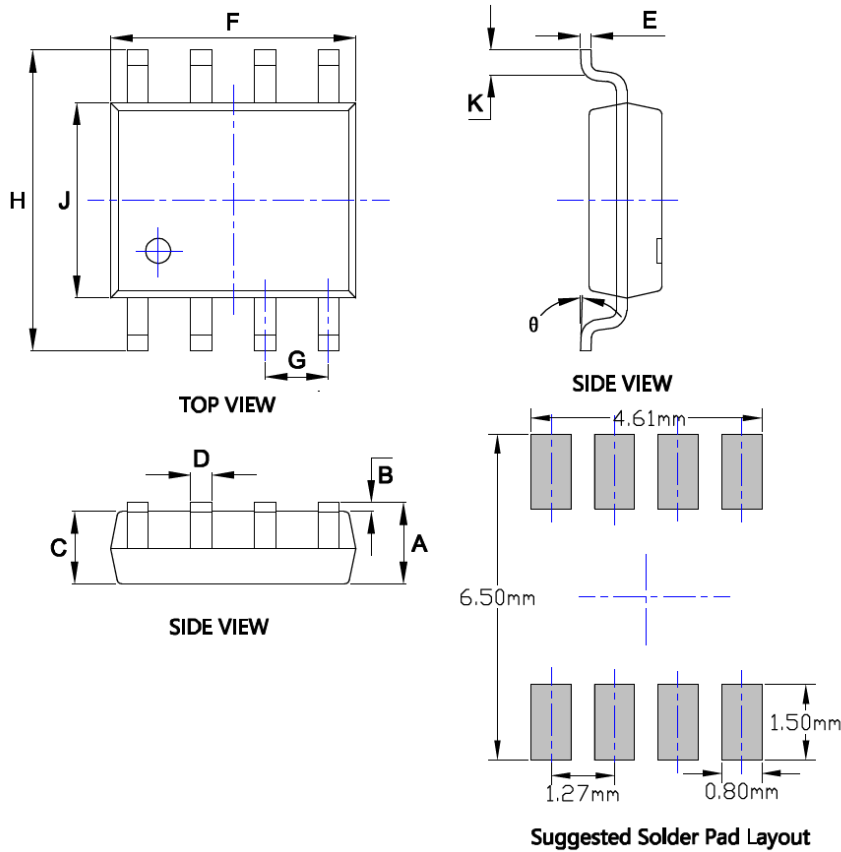

Figure 10. Current dissipation



YJS06GP06A

■ SOP-8 Package information



SYMBOL	DIMENSIONS			
	INCHES		Millimeter	
	MIN.	MAX.	MIN.	MAX.
A	0.053	0.069	1.350	1.750
B	0.004	0.010	0.100	0.250
C	0.053	0.061	1.350	1.550
D	0.013	0.020	0.330	0.510
E	0.007	0.010	0.170	0.250
F	0.189	0.197	4.800	5.000
G	0.050BSC		1.270BSC	
H	0.228	0.244	5.800	6.200
J	0.150	0.157	3.800	4.000
K	0.016	0.050	0.400	1.270
θ	0°	8°	0°	8°

Note:
 1. Controlling dimension: in millimeters.
 2. General tolerance: $\pm 0.05\text{mm}$.
 3. The pad layout is for reference purposes only.



YJS06GP06A

Disclaimer

The information presented in this document is for reference only. Yangzhou Yangjie Electronic Technology Co., Ltd. reserves the right to make changes without notice for the specification of the products displayed herein to improve reliability, function or design or otherwise.

The product listed herein is designed to be used with ordinary electronic equipment or devices, and not designed to be used with equipment or devices which require high level of reliability and the malfunction of which would directly endanger human life (such as medical instruments, transportation equipment, aerospace machinery, nuclear-reactor controllers, fuel controllers and other safety devices), Yangjie or anyone on its behalf, assumes no responsibility or liability for any damages resulting from such improper use of sale.

This publication supersedes & replaces all information previously supplied. For additional information, please visit our website [http:// www.21yangjie.com](http://www.21yangjie.com) , or consult your nearest Yangjie's sales office for further assistance.