

## Silicon Carbide Power MOSFET (N-Channel Enhancement)

$V_{DS}$	650V
$I_D$ (25°C)	33A
$R_{DS(on)}$	50mΩ

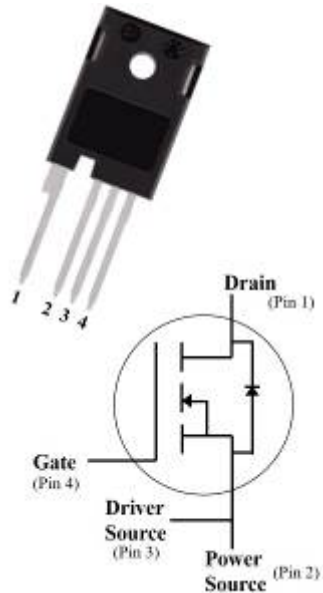

### Features

- High speed switching
- Essentially no switching losses
- Reduction of heat sink requirements
- Maximum working temperature at 175 °C
- High blocking voltage
- Fast Intrinsic diode with low recovery current
- High-frequency operation
- Halogen free, RoHS compliant

### Typical Applications

Typical applications are in power factor correction(PFC), solar inverter, uninterruptible power supply, motor drives, photovoltaic inverter, electric car and charger.

### Mechanical Data

- **Package:** TO247-4L
- **Terminals:** Tin plated leads
- **Polarity:** As marked

### ■Maximum Ratings ( $T_C=25^\circ\text{C}$ Unless otherwise specified)

PARAMETER	SYMBOL	UNIT	VALUE	TEST CONDITIONS	NOTE
Device marking code			D206550NCFGG2		
Drain source voltage @ $T_J=25^\circ\text{C}$	$V_{DS,max}$	V	650	$V_{GS}=0\text{ V}, I_D=100\mu\text{A}$	
Gate source voltage @ $T_J=25^\circ\text{C}$	$V_{GS,max}$	V	-8/+22	Absolute maximum values	
Gate source voltage @ $T_J=25^\circ\text{C}$	$V_{GS,op}$	V	-5/+18	Recommended operational values	
Continuous drain current @ $T_C=25^\circ\text{C}$	$I_D$	A	33	$V_{GS}=18\text{V}, T_C=25^\circ\text{C}$	Fig.17
Continuous drain current @ $T_C=100^\circ\text{C}$			25	$V_{GS}=18\text{V}, T_C=100^\circ\text{C}$	
Pulsed drain current	$I_{D(pulsed)}$	A	90	Pulse width $t_p$ limited by $T_{J,max}$	Fig.22
Power Dissipation	$P_{TOT}$	W	131	$T_C=25^\circ\text{C}, T_J = 175^\circ\text{C}$	Fig.16
Power Dissipation			65	$T_C=100^\circ\text{C}, T_J = 175^\circ\text{C}$	
Operating junction and Storage temperature range	$T_J, T_{stg}$	°C	-55 to +175		
Soldering temperature	$T_L$	°C	260	1.6mm (0.063") from case for 10s	
Mounting torque	$T_M$	Nm	0.6	M3 screw Maximum of mounting process: 3	



### ■Static Electrical Characteristics (Tc=25°C unless otherwise specified)

PARAMETER	SYMBOL	UNIT	Min.	Typ.	Max.	Test Conditions	Note
Gate threshold voltage	$V_{GS(th)}$	V	2.0	3.2	4.0	$V_{DS}=V_{GS}, I_D=5mA, T_j=25^\circ C$	Fig.4, 11
				2.3		$V_{DS}=V_{GS}, I_D=5mA, T_j=175^\circ C$	
Drain source breakdown voltage	$V_{(BR)DSS}$	V	650			$V_{GS}=0V, I_D=100\mu A$	
Gate source leakage current	$I_{GSS}$	nA		50	200	$V_{GS}=18V, V_{DS}=0V$	
Current drain source on-state resistance	$R_{DS(on)}$	mΩ		50	55	$V_{GS}=18V, I_D=20A, T_j=25^\circ C$	Fig.5, 6, 7
				75		$V_{GS}=18V, I_D=20A, T_j=175^\circ C$	
Internal gate resistance	$R_g$	Ω		6.0		$f=1MHz, V_{AC}=25mV$	
Transconductance	$g_{fs}$	S		20		$V_{DS}=20V, I_D=20A, T_j=25^\circ C$	Fig.4
				17		$V_{DS}=20V, I_D=20A, T_j=175^\circ C$	

### ■Dynamic Electrical Characteristics (Tc=25°C unless otherwise specified)

PARAMETER	SYMBOL	UNIT	Min.	Typ.	Max.	Test Conditions	Note
Input capacitance	$C_{iss}$	pF		1600		$V_{DS}=400V, V_{GS}=0V, T_j=25^\circ C, f=1MHz, V_{AC}=25mV$	Fig.13, 14
Output capacitance	$C_{oss}$			70			
Reverse capacitance	$C_{rss}$			12			
Coss stored energy	$E_{oss}$	uJ		21			Fig.15
Gate source charge	$Q_{gs}$	nC		21		$V_{DD}=400V, V_{GS}=-5/18V, I_D=20A$	Fig.12
Gate drain charge	$Q_{gd}$			32			
Gate charge	$Q_g$			82			

### ■Switching Characteristics (Tc=25°C unless otherwise specified)

PARAMETER	SYMBOL	UNIT	Min.	Typ.	Max.	Test Conditions	Note
Turn on switching energy	$E_{on}$	uJ		110		$V_{DS}=400V, V_{GS}=-5/+18V, I_D=20A, R_g=5\Omega, L=200\mu H$	Fig. 19, 20
Turn off switching energy	$E_{off}$			32			
Turn on delay time	$t_{d(on)}$	ns		22		$V_{DD}=400V, V_{GS}=-5/+18V, I_D=20A, R_g=5\Omega, L=200\mu H$	Fig.21
Rise time	$t_r$			12			
Turn off delay time	$t_{d(off)}$			28			
Fall time	$t_f$			11			

## ■Body diode characteristics (T<sub>c</sub>=25°C unless otherwise specified)

PARAMETER	SYMBOL	UNIT	Min.	Typ.	Max.	Test Conditions	Note
Diode forward voltage	V <sub>SD</sub>	V		3.4		V <sub>GS</sub> =-5V, I <sub>SD</sub> =10A, T <sub>j</sub> =25°C	Fig.8
				3.2		V <sub>GS</sub> =0V, I <sub>SD</sub> =10A, T <sub>j</sub> =175°C	Fig.9
Continuous diode forward current	I <sub>s</sub>	A		60		T <sub>c</sub> =25°C	
Reverse recovery time	t <sub>rr</sub>	nS		20		V <sub>R</sub> =400V, V <sub>GS</sub> =-5V, I <sub>SD</sub> =20A, di/dt=1200A/us	
Reverse recovery charge	Q <sub>rr</sub>	nC		65			
Peak reverse recovery current	I <sub>rrm</sub>	A		8			

## ■Thermal Characteristics (T<sub>a</sub>=25°C Unless otherwise specified)

PARAMETER	SYMBOL	UNIT	Typ.
Thermal resistance	R <sub>θj-c</sub>	°C/W	1.14

## ■Typical Characteristics

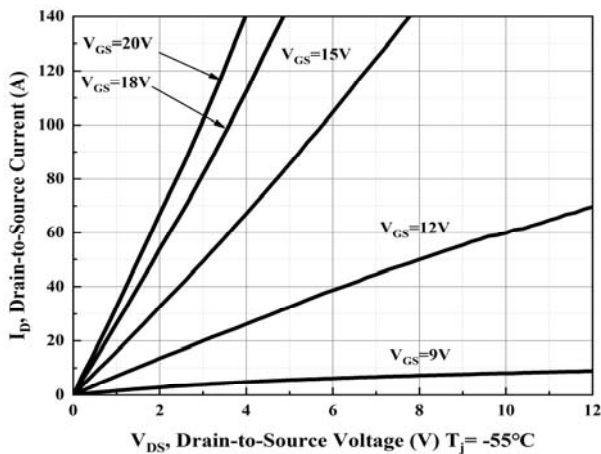

Figure 1. Output Characteristics T<sub>j</sub> = -55°C

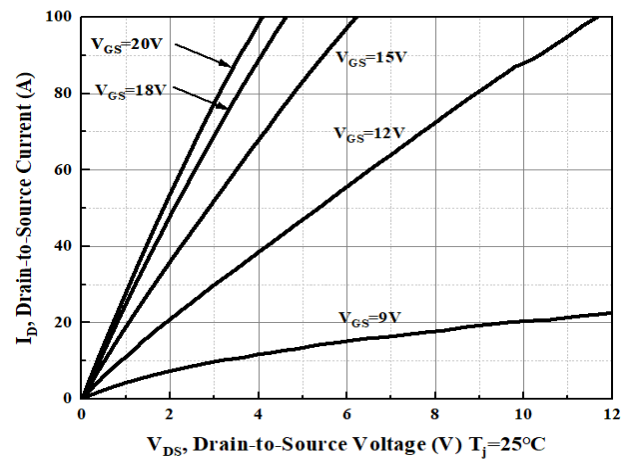

Figure2. Output Characteristics T<sub>j</sub> = 25°C

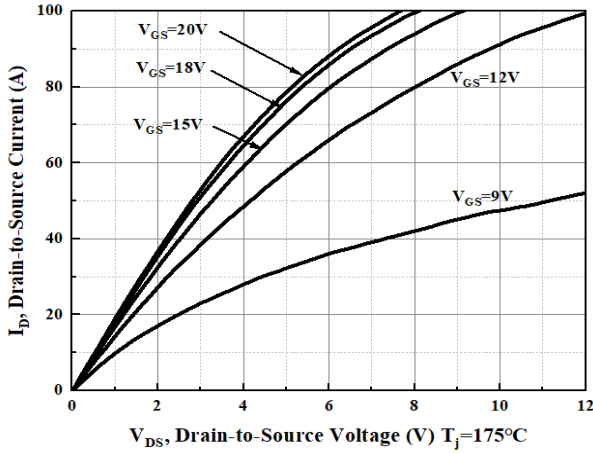

Figure 3. Output Characteristics Tj = 175°C

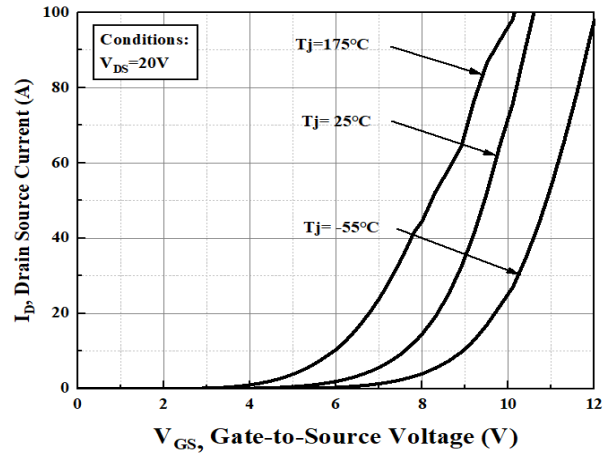

Figure 4. Transfer Characteristics for Various Junction Temperature

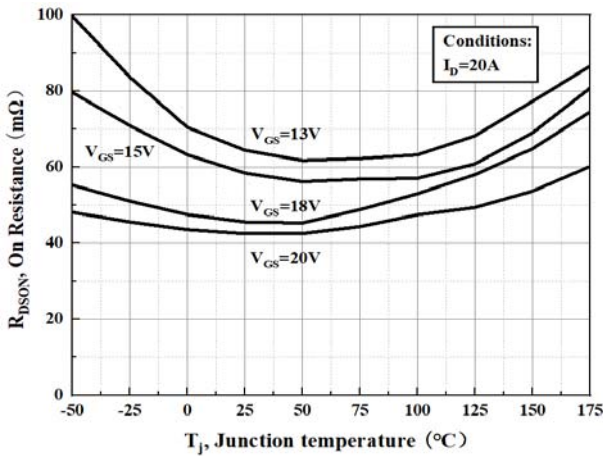

Figure 5. On-resistance vs. Temperature for Various Gate Voltage

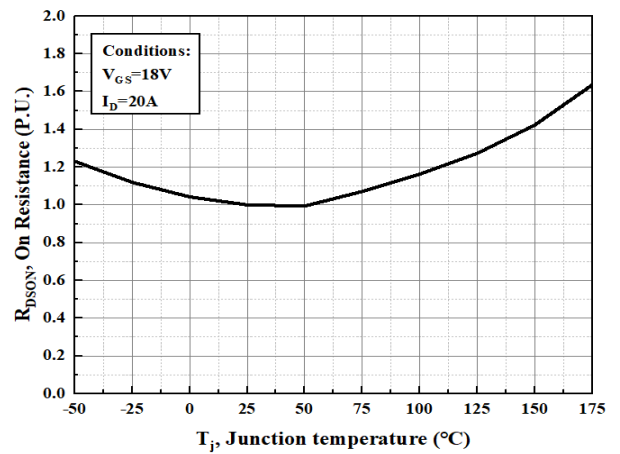

Figure 6. Normalized on-resistance vs. Temperature

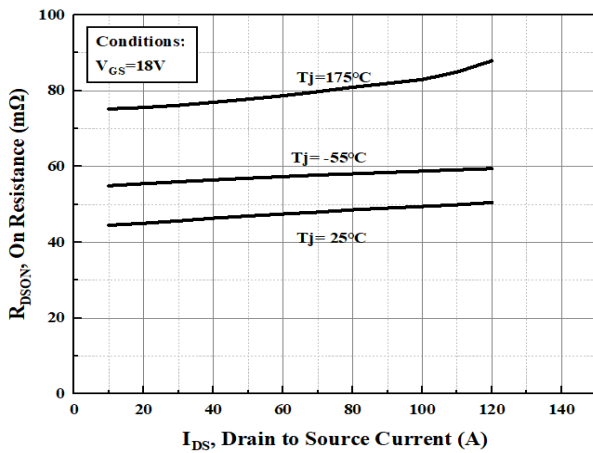

Figure 7. On-resistance vs. Drain Current

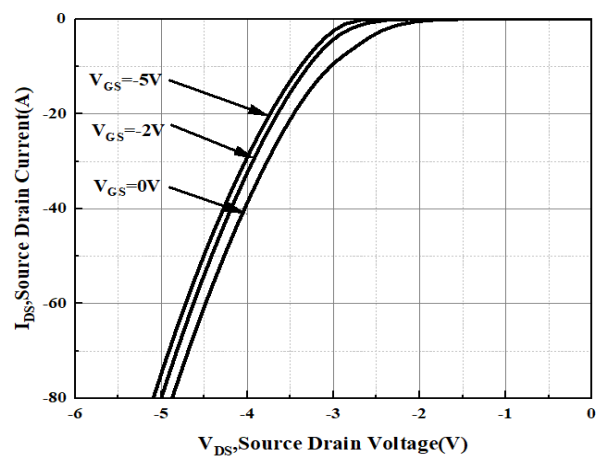

Figure 8. Body Diode Characteristic at Tj = 25 °C

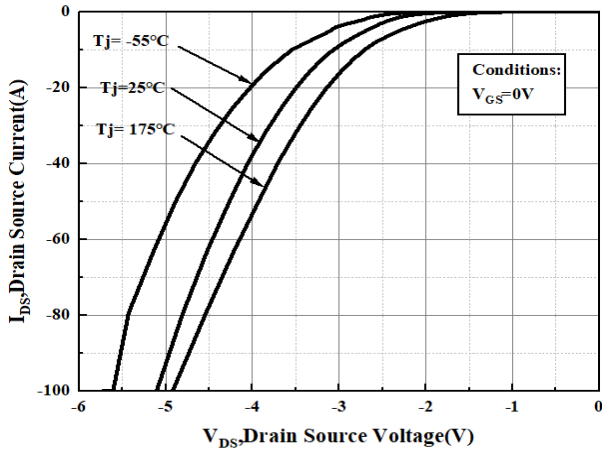

Figure 9. Body Diode Characteristic

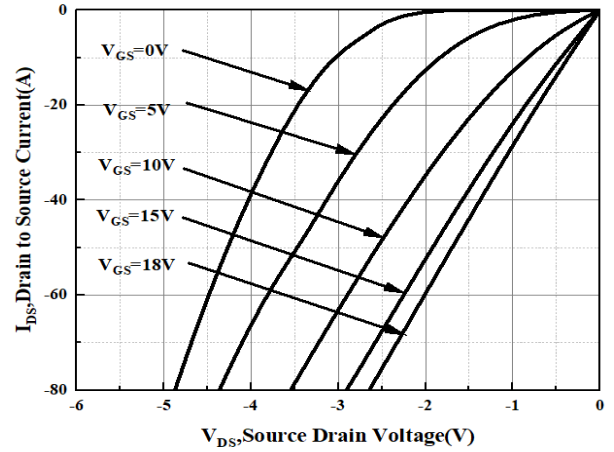

Figure 10. 3<sup>rd</sup> quadrant Characteristic at  $T_j = 25^\circ\text{C}$

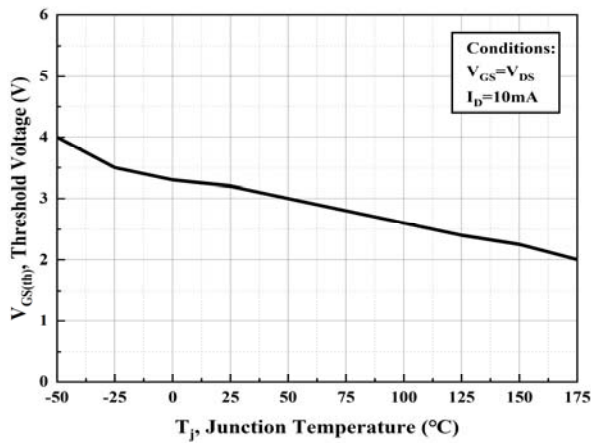

Figure 11. Threshold Voltage vs. Temperature

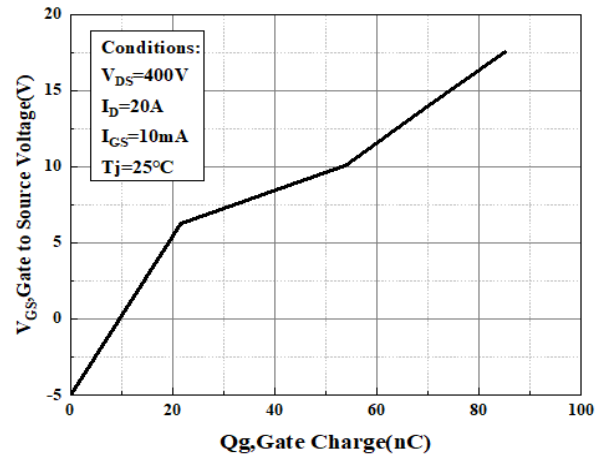

Figure 12. Gate Charge Characteristic

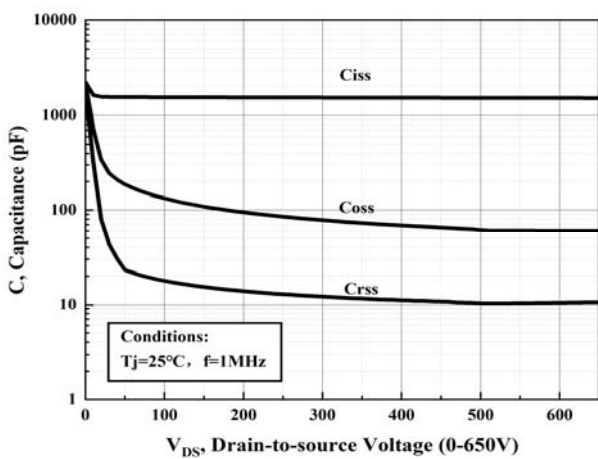

Figure 13. Capacitances vs. Drain Source Voltage (0-650V)

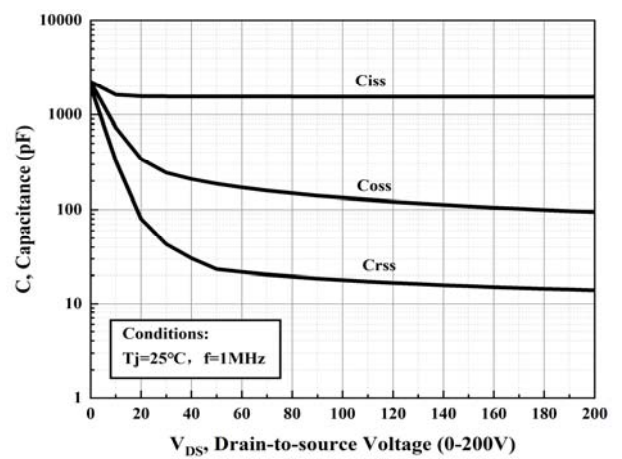

Figure 14. Capacitances vs. Drain Source Voltage (0-200V)

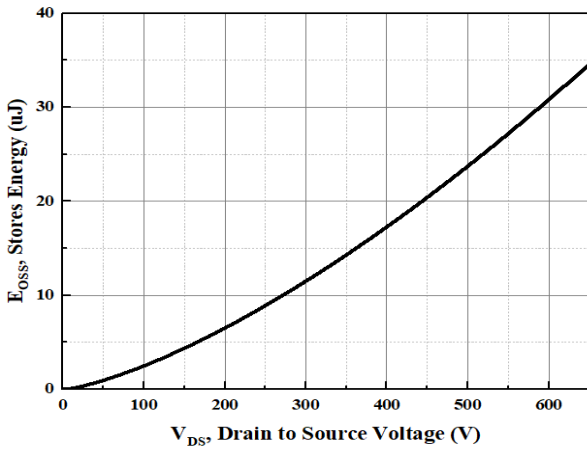

Figure 15. Output Capacitor Stored Energy

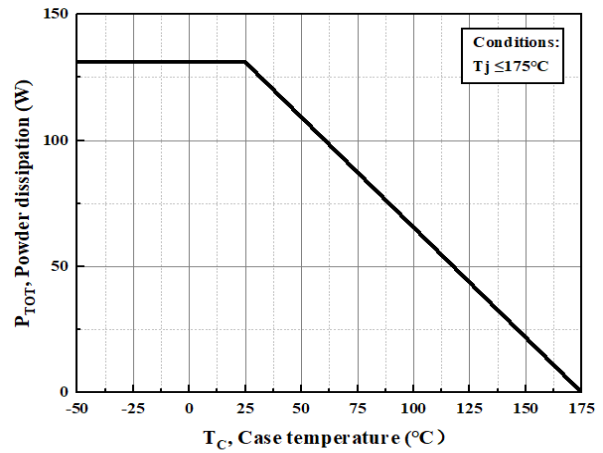

Figure 16. Maximum Power Dissipation Derating vs. Case Temperature

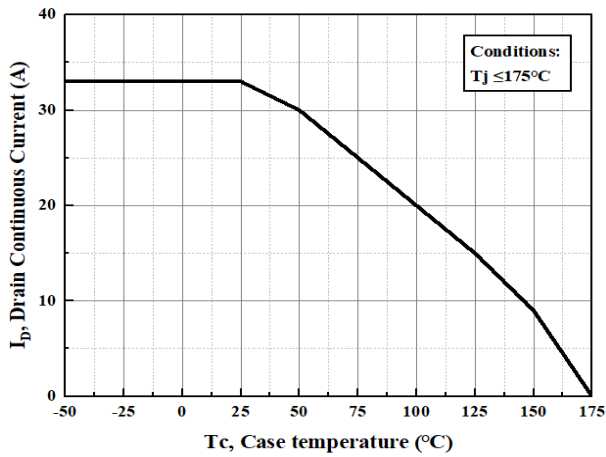

Figure 17. Continuous Drain Current Derating vs Case Temperature

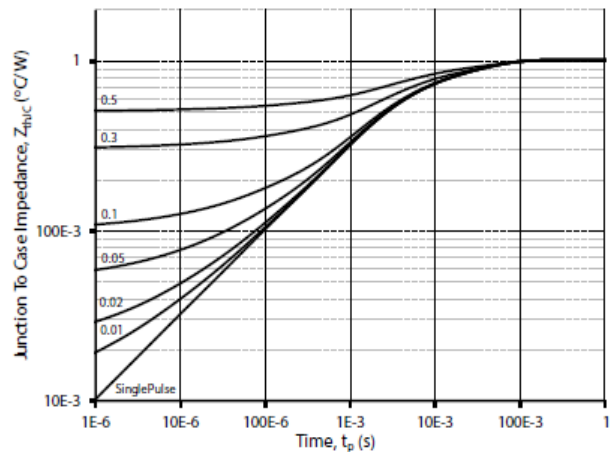

Figure 18. Transient Thermal Impedance (Junction - Case)

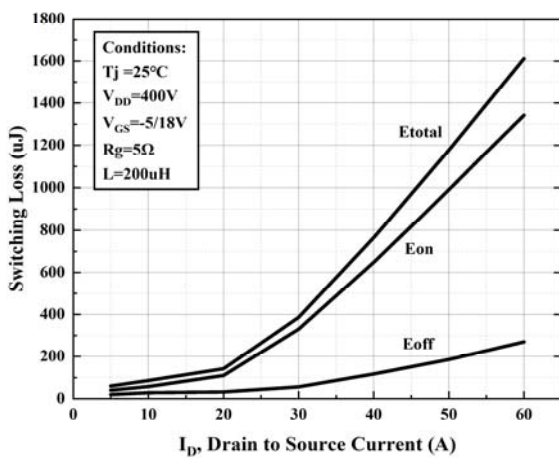

Figure 19. Clamped Inductive Switching Energy vs. Drain Current

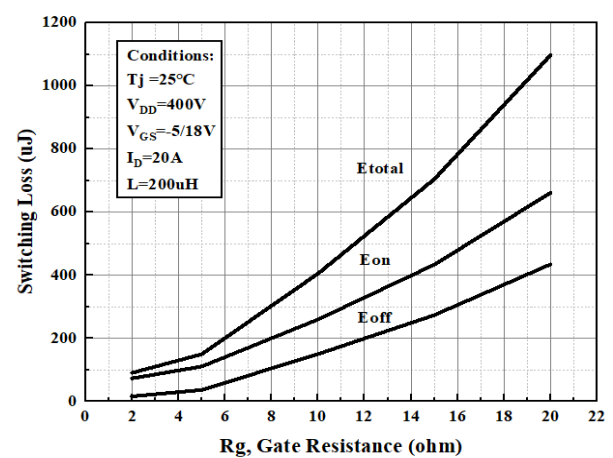

Figure 20. Clamped Inductive Switching Energy vs. Rg

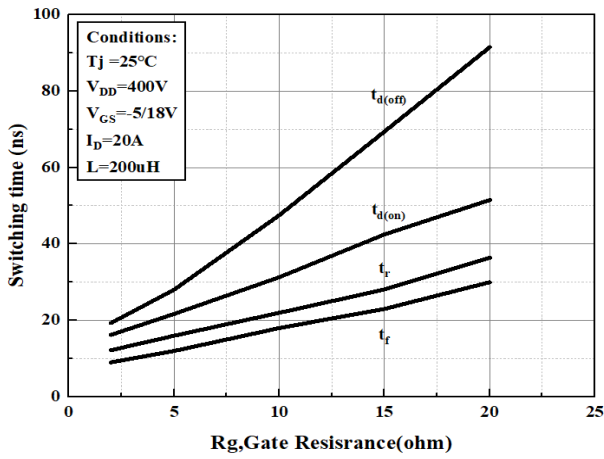

Figure 21. Switching Times vs. Rg

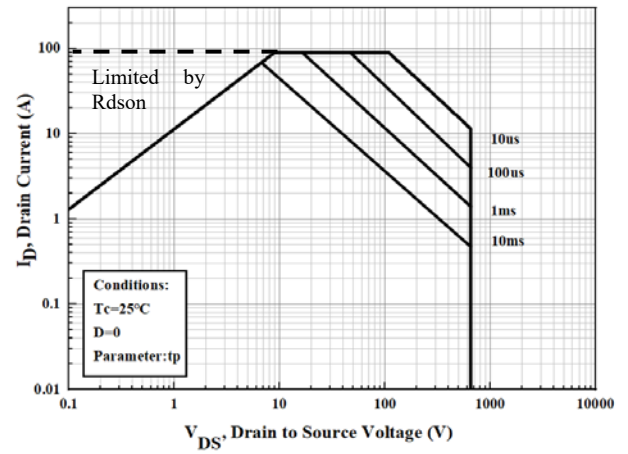

Figure 22. Safe Operating Area

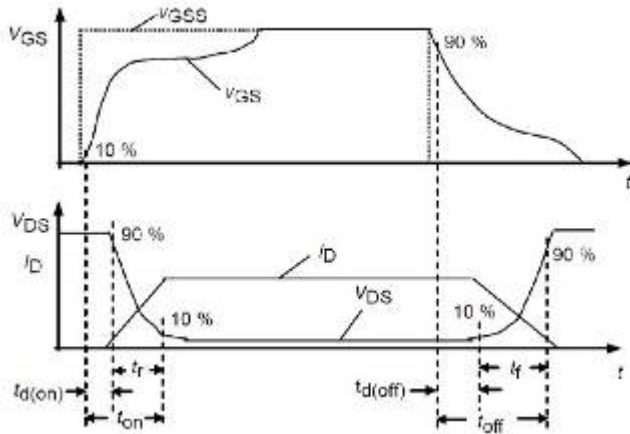

Figure 23. Switching Times Definition

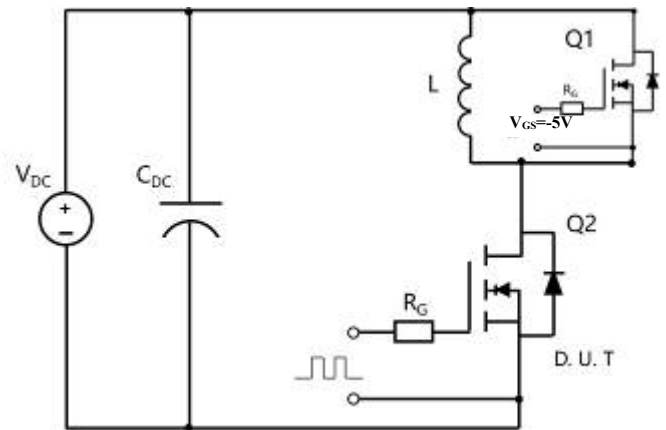
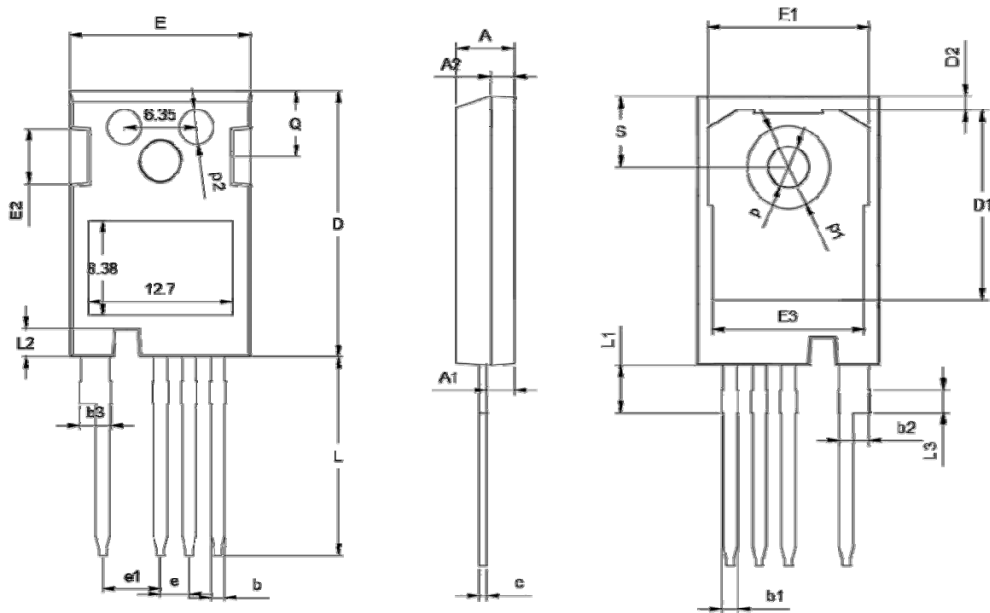

Figure 24. Clamped Inductive Switching Waveform Test Circuit



## ■Outline Dimensions



TO247-4L			
Dim	Min	Norm	Max
A	4.80	5.00	5.20
A1	2.30	2.40	2.50
A2	1.88	1.98	2.08
b	1.10	1.20	1.30
b1	1.20	/	1.50
b2	2.35	2.55	2.75
b3	2.45	/	2.85
c	0.55	0.60	0.65
D	23.3	23.45	23.6
D1	16.25	16.55	16.85
D2	1.00	/	1.30
e	TYP2.54		
e1	TYP5.06		
E	15.75	15.90	16.05
E1	13.80	/	14.20
E2	4.40	4.75	5.10
E3	13.00	/	13.45
L	17.34	17.49	17.64
L1	4.00	/	4.30
L2	2.35	/	2.65
L3	TYP1.98		
Q	5.60	5.80	6.00
S	6.05	/	6.30
p	TYP3.58		
p1	TYP7.18		
p2	TYP3.00		





## Disclaimer

The information presented in this document is for reference only. Yangzhou Yangjie Electronic Technology Co., Ltd. reserves the right to make changes without notice for the specification of the products displayed herein to improve reliability, function or design or otherwise.

The product listed herein is designed to be used with ordinary electronic equipment or devices, and not designed to be used with equipment or devices which require high level of reliability and the malfunction of which would directly endanger human life (such as medical instruments, transportation equipment, aerospace machinery, nuclear-reactor controllers, fuel controllers and other safety devices), Yangjie or anyone on its behalf, assumes no responsibility or liability for any damages resulting from such improper use of sale.

This publication supersedes & replaces all information previously supplied. For additional information, please visit our website [http:// www.21yangjie.com](http://www.21yangjie.com) , or consult your nearest Yangjie's sales office for further assistance.